

PENTAX
A RICOH COMPANY



SLR Digital Camera

K-50

Operating Manual

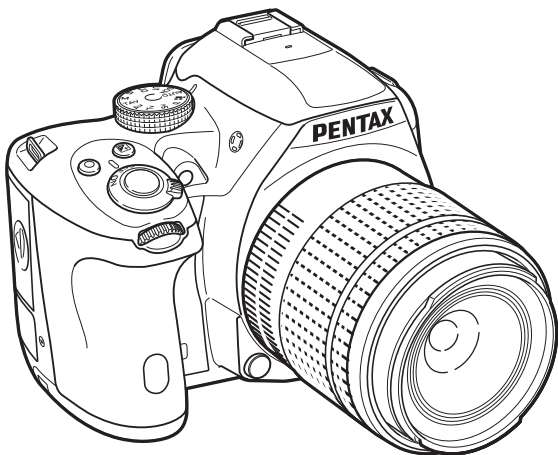

To ensure the best performance from your camera, please read the Operating Manual before using the camera.

Thank you for purchasing this PENTAX K-50 Digital Camera. Please read this manual before using the camera in order to get the most out of all the features and functions. Keep this manual safe, as it can be a valuable tool in helping you to understand all the camera's capabilities.

Lenses you can use

In general, lenses that can be used with this camera are DA, DA L, D FA and FA J lenses and lenses that have an **A** position on the aperture ring. To use any other lens or accessory, see p.54 and p.261.

Regarding copyrights

Images taken with the K-50 that are for anything other than personal enjoyment cannot be used without permission according to the rights as specified in the Copyright Act. Please take care, as there are cases where limitations are placed on taking pictures even for personal enjoyment during demonstrations, performances or of items on display. Images taken with the purpose of obtaining copyrights also cannot be used outside the scope of use of the copyright as laid out in the Copyright Act, and care should be taken here also.

Regarding trademarks

Microsoft and Windows are registered trademarks of Microsoft Corporation in the United States and other countries. Windows Vista is either a registered trademark or trademark of Microsoft Corporation in the United States and/or other countries.

Macintosh, Mac OS, and QuickTime are trademarks of Apple Inc., registered in the U.S. and other countries.

Intel, Intel Core, and Pentium are trademarks of Intel Corporation in the U.S. and other countries.

SDXC Logo is a trademark of SD-3C, LLC.

Eye-Fi, the Eye-Fi logo and Eye-Fi *connected* are trademarks of Eye-Fi, Inc.

This product includes DNG technology under license by Adobe Systems Incorporated.

The DNG logo is either a registered trademark or trademark of Adobe Systems Incorporated in the United States and/or other countries.

All other trademarks are the property of their respective owners.

This product supports PRINT Image Matching III. PRINT Image Matching enabled digital still cameras, printers and software help photographers to produce images more faithful to their intentions. Some functions are not available on printers that are not PRINT Image Matching III compliant.

Copyright 2001 Seiko Epson Corporation. All Rights Reserved. PRINT Image Matching is a trademark of Seiko Epson Corporation. The PRINT Image Matching logo is a trademark of Seiko Epson Corporation.

This product is licensed under the AVC Patent Portfolio License for the personal use of a consumer or other uses in which it does not receive remuneration to (i) encode video in compliance with the AVC standard ("AVC video") and/or (ii) decode AVC video that was encoded by a consumer engaged in a personal activity and/or was obtained from a video provider licensed to provide AVC video. No license is granted or shall be implied for any other use. Additional information may be obtained from MPEG LA, L.L.C.

See <http://www.mpegla.com>.

To users of this camera

- Do not use or store this camera in the vicinity of equipment that generates strong electromagnetic radiation or magnetic fields. Strong static charges or the magnetic fields produced by equipment such as radio transmitters could interfere with the monitor, damage the stored data, or affect the camera's internal circuitry and cause camera misoperation.
- The liquid crystal panel used for the monitor is manufactured using extremely high precision technology. Although the level of functioning pixels is 99.99% or better, you should be aware that 0.01% or fewer of the pixels may not illuminate or may illuminate when they should not. However, this has no effect on the recorded image.
- There is a possibility that the illustrations and the display screen of the monitor in this manual are different from the actual ones.
- In this manual, SD Memory Cards, SDHC Memory Cards, SDXC Memory Cards and Eye-Fi Cards are referred to as "SD Memory Cards".
- In this manual, the generic term "computer(s)" refers to either a Windows PC or a Macintosh.
- This camera can use either D-LI109 battery or AA battery holder D-BH109 with four AA batteries. In this manual, both D-LI109 and D-BH109 are referred to as the battery unless otherwise stated.
Except mentioned above, the generic term "battery(ies)" refers to any type of batteries used for this camera and its accessories.

For Using Your Camera Safely

We have paid close attention to the safety of this camera. When using this camera, we request your special attention regarding items marked with the following symbols.



Warning

This symbol indicates that ignoring this item could cause serious personal injuries.



Caution

This symbol indicates that ignoring this item could cause minor or medium personal injuries, or loss of property.

About the Camera



Warning

- Do not disassemble or modify the camera. High voltage areas are present inside the camera, with the risk of electric shock.
- If the camera interior is exposed due to dropping or otherwise damaging the camera, never touch the exposed portion. There is a risk of electric shock.
- Do not aim the camera at the sun or other strong light sources when taking pictures or leave the camera sitting in direct sunlight with the lens cap off. Doing so may cause the camera to malfunction or cause a fire.
- Do not look at the sun or other strong light sources through the lens. Doing so may lead to a loss of eyesight or cause vision to be impaired.

- If any irregularities occur during use, such as smoke or a strange odor, stop use immediately, remove the battery or the AC adapter, and contact your nearest PENTAX Service Center. Continued use can cause a fire or electrical shock.



Caution

- Do not place your finger over the flash when discharging the flash. You may burn yourself.
- Do not cover the flash with clothing when discharging the flash. Discoloration may occur.
- Some portions of the camera heat up during use. There is a risk of low temperature burns when holding such portions for long periods.
- Should the monitor be damaged, be careful of glass fragments. Also, be careful not to allow the liquid crystal to get on your skin or in your eyes or mouth.
- Depending on your individual factors or physical condition, the use of the camera may cause itching, rashes or blisters. In case of any abnormality, stop using the camera and get medical attention immediately.

About the Battery Charger and AC Adapter



Warning

- Always use the battery charger and AC adapter exclusively developed for this camera, with the specified power and voltage. Using a battery charger or AC adapter not exclusive to this camera, or using the exclusive battery charger or AC adapter with an unspecified power or voltage can cause a fire, electric shock, or camera breakdown. The specified voltage is 100 - 240V AC.
- Do not disassemble or modify the product. This can cause a fire or electrical shock.
- If the generation of smoke or strange odor from the product or other abnormality occurs, immediately discontinue using and consult a PENTAX Service Center. Continued use can cause a fire or electrical shock.
- If water should happen to get inside the product, consult a PENTAX Service Center. Continued use can cause a fire or electrical shock.
- If you see a lightning flash or hear thunder during use of the battery charger or AC adapter, unplug the power plug and discontinue use. Continued use can cause damage to the product, fire or electrical shock.
- Wipe off the power plug if it should become covered with dust. Accumulated dust may cause a fire.
- To reduce the risk of hazards, use only CSA/UL certified power supply cord set, cord is Type SPT-2 or heavier, minimum NO.18 AWG copper, one end with a molded-on male attachment plug cap (with a specified NEMA configuration), and the other is provided with a molded-on female connector body (with a specified IEC nonindustrial type configuration) or the equivalent.



Caution

- Do not place or drop heavy objects on or forcefully bend the AC plug cord. Doing so may damage the cord. Should the AC plug cord be damaged, consult a PENTAX Service Center.

- Do not touch or short-circuit the terminal area of the AC plug cord while the cord is plugged in.
- Do not handle the power plug with wet hands. This can cause an electric shock.
- Do not drop the product, or subject it to violent impact. This can cause the product breakdown.
- Do not use the battery charger D-BC109 to charge batteries other than the rechargeable lithium-ion battery D-LI109. Attempting to charge other types of batteries may cause an explosion or heating, or may damage the battery charger.

About the Rechargeable Lithium-ion Battery



Warning

- If any leakage from the battery should come in contact with your eyes, do not rub them. Flush your eyes with clean water and get medical attention immediately.



Caution

- Only use the specified battery with this camera. Use of other batteries may cause an explosion or fire.
- Do not disassemble the battery. Disassembling the battery may cause an explosion or leakage.
- Remove the battery from the camera immediately if it becomes hot or begins to smoke. Be careful not to burn yourself during removal.
- Keep wires, hairpins, and other metal objects away from the + and - contacts of the battery.
- Do not short the battery or dispose of the battery in fire. This can cause an explosion or fire.
- If any leakage from the battery should come in contact with skin or clothing, it may cause irritation to the skin. Wash the affected areas thoroughly with water.
- Precautions for D-LI109 Battery Usage:
USE SPECIFIED CHARGER ONLY.
 - DO NOT INCINERATE.
 - DO NOT DISASSEMBLE.
 - DO NOT SHORT CIRCUIT.
 - DO NOT EXPOSE TO HIGH TEMP. (140°F/60°C)

About the Usage of AA Batteries



Warning

- If any leakage from the battery should come in contact with your eyes, do not rub them. Flush your eyes with clean water and get medical attention immediately.



Caution

- When using the optional AA battery holder D-BH109, four AA alkaline, AA lithium or AA Ni-MH batteries can be used. Do not use batteries other than those specified here. Using other types of batteries may cause the camera to function poorly, or the batteries may explode or cause a fire.

- The batteries should be inserted correctly, observing (+) and (-) marks on the batteries. Inserting the batteries incorrectly may cause an explosion or fire.
- When replacing the batteries, do not combine different brands, types or capacities. Also, do not combine old batteries with new ones. Inserting the batteries incorrectly may cause an explosion or fire.
- Do not short the batteries or dispose of the batteries in fire. Do not disassemble the batteries. The batteries could explode or catch fire.
- Do not charge any batteries other than rechargeable Ni-MH batteries. The batteries could explode or catch fire. AA batteries for use with this camera other than Ni-MH batteries cannot be charged.
- Do not open the battery cover or remove the batteries while the power is on.
- Remove the batteries when you do not plan to use the camera for a long time. The batteries may leak.
- If any leakage from the battery should come in contact with skin or clothes, it may cause irritation to the skin. Wash the affected areas thoroughly with water.
- Remove the batteries from the camera immediately if they become hot or begin to smoke. Be careful not to burn yourself during removal.

Keep the Camera and its Accessories out of the Reach of Small Children



Warning

- Do not place the camera and its accessories within the reach of small children.
 1. If the product falls or is operated accidentally, it may cause serious personal injuries.
 2. Wrapping the strap around a neck may cause suffocation.
 3. To avoid the risk of a small accessory such as the battery or SD Memory Cards from being swallowed by mistake, keep them out of the reach of small children. Seek medical attention immediately if an accessory is accidentally swallowed.

Care to be Taken During Handling

Before Using Your Camera

- When traveling, take the Worldwide Service Network listing that is included in the package. This will be useful if you experience problems abroad.
- When the camera has not been used for a long time, confirm that it is still working properly, particularly prior to taking important pictures (such as at a wedding or when traveling). Contents of the recording cannot be guaranteed if recording, playback or transferring your data to a computer, etc. is not possible due to a malfunction of your camera or recording media (SD Memory Card), etc.

About the Battery and Charger

- To keep the battery in optimum condition, avoid storing it in a fully charged state or in high temperatures.
- If the battery is left inserted and the camera is not used for a long time, the battery will over-discharge and shorten the battery's life.
- Charging the battery a day before use or on the day of use is recommended.
- The AC plug cord provided with this camera is developed exclusively for the battery charger D-BC109. Do not use it with other devices.

Precautions on Carrying and Using Your Camera

- Do not subject the camera to high temperatures or high humidity. Do not leave the camera in a vehicle, as the temperature can get very high.
- Do not subject the camera to strong vibrations, shocks, or pressure. Use a cushion to protect the camera from vibrations of motorcycles, automobiles, or ships.
- The temperature range for camera use is -10°C to 40°C (14°F to 104°F).
- The monitor may appear black at high temperatures, but will return to normal at normal temperatures.
- The monitor may respond more slowly at low temperatures. This is due to liquid crystal properties, and is not a malfunction.
- Sudden temperature changes will cause condensation on the inside and outside of the camera. Place the camera in your bag or a plastic bag, and remove it after temperature of the camera and surroundings are equalized.
- Avoid contact with garbage, mud, sand, dust, water, toxic gases, or salt. These could cause the camera to breakdown. Wipe the camera to dry off any rain or water drops.
- Do not press the monitor with excessive force. This could cause it to break or malfunction.
- Be careful not to overtighten the screw in the tripod socket when using a tripod.

Cleaning Your Camera

- Do not clean the camera with organic solvents such as thinner, alcohol, or benzine.
- Use a lens brush to remove dust accumulated on the lens or viewfinder. Never use a spray blower for cleaning as it may damage the lens.
- Please contact a PENTAX Service Center for professional cleaning of the CMOS sensor. (This will involve a fee.)
- Periodic inspections are recommended every one to two years to maintain high performance.

Storing Your Camera

- Do not store the camera with preservatives or chemicals. Storage in high temperatures and high humidity can cause mold to grow on the camera. Remove the camera from its case and store it in a dry and well-ventilated place.

- Avoid using or storing the camera where it may be exposed to static electricity or electrical interference.
- Avoid using or storing the camera in direct sunlight or in locations where it may be exposed to rapid changes in temperature or to condensation.

About SD Memory Cards

- The SD Memory Card is equipped with a write-protect switch. Setting the switch to LOCK prevents new data from being recorded on the card, the stored data from being deleted, and the card from being formatted by the camera or computer.
- The SD Memory Card may be hot when removing the card immediately after using the camera.
- Do not remove the SD Memory Card or turn off the power while the card is being accessed. This may cause the data to be lost or the card to be damaged.
- Do not bend the SD Memory Card or subject it to violent impact. Keep it away from water and store away from high temperatures.
- Do not remove the SD Memory Card while formatting. The card may be damaged and become unusable.
- Data on the SD Memory Card may be deleted in the following circumstances. We do not accept any liability for data that is deleted if
 1. the SD Memory Card is mishandled by the user.
 2. the SD Memory Card is exposed to static electricity or electrical interference.
 3. the SD Memory Card has not been used for a long time.
 4. the SD Memory Card or the battery is removed while the card is being accessed.
- If the SD Memory Card is not used for a long time, the data on the card may become unreadable. Be sure to regularly make a backup of important data on a computer.
- Format new SD Memory Cards. Also format SD Memory Cards previously used with other cameras or devices.
- Please note that deleting data stored on an SD Memory Card, or formatting an SD Memory Card does not completely erase the original data. Deleted data can sometimes be recovered using commercially available software. If you are going to discard, give away or sell your SD Memory Card, you should ensure that the data on the card is completely deleted or the card itself is destroyed if it contains any personal or sensitive information.
- The data on your SD Memory Card should be managed at your own risk.

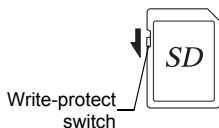

About Eye-Fi Cards

- An SD Memory Card with a built-in wireless LAN ("Eye-Fi card") can be used with this camera.
- Use of an access point and an Internet connection are required for transferring images via wireless LAN. For details, refer to the Eye-Fi website. (<http://www.eye.fi>)
- Use Eye-Fi cards which have been updated to the newest firmware.

- Set [Eye-Fi] to [Off], or do not use an Eye-Fi card in a location where the use of wireless LAN devices is restricted or prohibited, such as airplanes.
- Eye-Fi cards can be used only in the country in which the card was purchased. Please observe all local laws governing Eye-Fi card usage.
- This camera features a function to enable/disable the communication function of the Eye-Fi card, however, we do not guarantee the operability of all Eye-Fi card functions.
- Refer to the Eye-Fi card manual for details on how to use the card.
- Please contact the Eye-Fi card manufacturer regarding any malfunctions or problems concerning Eye-Fi cards.

Regarding User Registration

In order to better serve you, we request that you complete the user registration, which can be found on the CD-ROM supplied with the camera or on the PENTAX website. Refer to p.239 for details. Thank you for your cooperation.

Memo

Contents

For Using Your Camera Safely	1
Care to be Taken During Handling	4
Contents	9
Composition of the Operating Manual	15

Before Using Your Camera **17**

Checking the Contents of the Package 18

Names and Functions of the Working Parts 19

Capture Mode	20
Playback Mode	22
Monitor Display	24
Viewfinder	35

How to Change Function Settings 38

Using the Direct Keys	38
Using the Control Panel	39
Using the Menus	40

Getting Started **43**

Attaching the Strap 44

Inserting the Battery 45

Using the Lithium-ion Battery	45
Using the AA Batteries	48
Using the AC Adapter	50

Inserting/Removing an SD Memory Card 52

Attaching a Lens 54

Adjusting the Viewfinder Diopter 56

Turning the Camera On and Off 57

Initial Settings 58

Setting the Display Language	58
Setting the Date and Time	60

Basic Operations

63

Basic Shooting Operation	64
Letting the Camera Choose the Optimal Settings.....	64
Using the Built-in Flash	68
Setting the Flash Mode	68
Using the Built-in Flash	71
Reviewing Images	72
Playing Back Images	72
Deleting a Single Image	73

Shooting Functions

75

How to Operate the Shooting Functions	76
Direct Keys Setting Items.....	76
Rec. Mode Menu Items	77
Movie Menu Items.....	79
Custom Setting Menu Items.....	80
Selecting the Appropriate Capture Mode	82
Auto Picture Modes.....	83
Scene Modes	84
Exposure Modes	86
Setting the Exposure.....	87
Setting the Sensitivity.....	87
Changing the Exposure Mode	89
Adjusting the Exposure	92
Locking the Exposure Before Shooting (AE Lock).....	96
Selecting the Metering Method	97
Reducing the Image Noise (Noise Reduction).....	98
Focusing.....	101
Setting the Focus Mode	101
Selecting the Focusing Point (AF Point)	104
Setting the Contrast AF during Live View	106
Checking the Focus	109
Adjusting the Focus Manually (Manual Focus).....	110
AF Fine Adjustment	112
Checking the Depth of Field (Preview)	114
Displaying the Optical Preview	114
Displaying the Digital Preview.....	115

Using the Shake Reduction Function to Prevent Camera

Shake	116
Taking Pictures Using the Shake Reduction Function	116
Shooting with the Self-timer	119
Shooting with a Remote Control Unit (Optional)	121
Taking Pictures Continuously	123
Continuous Shooting	123
Interval Shooting	125
Multi-exposure	128
Recording Movies	130
Changing the Settings for Movie Recording	130
Recording Movies	132
Interval Movie	134
Playing Back Movies	136
Editing Movies	138

Shooting Settings

141

Setting a File Format	142
File Format	143
JPEG Recorded Pixels	143
JPEG Quality	144
Color Space	144
Setting the White Balance	145
Adjusting the White Balance Manually	147
Adjusting the White Balance with Color Temperature	149
Correcting Images	150
Brightness Adjustment	150
High Dynamic Range Image Capture	151
Lens Correction	153
Composition Adjustment	155
Setting the Image Finishing Tone	157
Custom Image	157
Digital Filter	161
Customizing the Button/E-dial Functions	164
Setting the E-dials Operation	164
Setting the RAW/Fx Button Operation	167
Setting the AF/AE-L Button Operation	169

Saving Frequently Used Settings	170
Saving the Settings	170
Checking the Saved USER Settings	173
Using Saved USER Settings	173
Resetting to Default Settings	174

Playback Functions and Image Editing 175

How to Operate the Playback/Edit Functions	176
Playback Mode Palette Items	176
Playback Menu Items	177
Setting the Playback Display Method	178
Selecting the Playback Functions	179
Magnifying Images	179
Displaying Multiple Images	180
Playing Back Images Continuously	183
Rotating Images	185
Deleting Multiple Images	186
Deleting Selected Images	186
Deleting a Folder	187
Deleting All Images	188
Processing Images	189
Changing the Number of Recorded Pixels (Resize)	189
Cutting Out Part of the Image (Cropping)	190
Processing Images with Digital Filters	191
Joining Multiple Images (Index)	196
Developing RAW Images	198
Developing One RAW Image	198
Developing Multiple RAW Images	200
Connecting the Camera to an AV Device	202
Connecting the Camera to a Video Input Terminal	202
Setting the Video Output Format	203

Changing Additional Settings 205

How to Operate the Set-up Menu	206
Set-up Menu Items	206
Camera Settings	208
Setting the Sound Effects, Date and Time, and Display	
Language	208
Setting the Monitor and the Menu Displays	212
Battery Settings	216
Selecting Settings to Save in the Camera (Memory)	217
Resetting the Camera Settings	219
Checking the Camera Version Information	220
File Management Settings	221
Formatting an SD Memory Card	221
Protecting Images from Deletion (Protect)	222
Setting the Naming System of the Folder	223
Creating New Folders	224
Setting the File Name	225
Setting the Photographer Information	226
Using an Eye-Fi Card	228
Setting the DPOF Settings	231

Connecting to a Computer 233

Manipulating Captured Images on a Computer	234
Saving Images on a Computer	235
Setting the USB Connection Mode	235
Connecting the Camera and a Computer	236
Using the Provided Software	237
Installing the Software	237

Using the Flash 241

Using the Built-in Flash	242
Flash Characteristics in Each Exposure Mode	242
Using the Slow-speed Sync Flash	242
Distance and Aperture when Using the Built-in Flash	244
Using an External Flash (Optional)	245
Using the P-TTL Auto Flash	246
Using the High-speed Sync Flash	247
Using Flash in Wireless Mode	248
Connecting an External Flash with an Extension Cord	250
Using the Contrast Control Sync Flash	252

Appendix 253

Default Settings	254
Functions Available with Various Lens Combinations	261
Setting the Focal Length	264
Using the Aperture Ring	265
Cleaning the CMOS Sensor	266
Removing Dust by Shaking the CMOS Sensor (Dust Removal)	266
Removing Dust with a Blower	267
Using the GPS Unit	269
Shooting Celestial Bodies (ASTROTRACER)	270
Error Messages	272
Troubleshooting	275
Main Specifications	278
Index	285
WARRANTY POLICY	292

Composition of the Operating Manual

This Operating Manual contains the following chapters.

1 Before Using Your Camera

Explains the provided accessories and the names and functions of the working parts.

2 Getting Started

Explains your first steps from purchasing the camera to taking pictures. Be sure to read this chapter and follow the instructions.

3 Basic Operations

Explains basic operations for taking and playing back pictures.

4 Shooting Functions

Explains shooting-related functions.

5 Shooting Settings

Explains procedures for changing the shooting settings, such as the file format.

6 Playback Functions and Image Editing

Explains various operations for playing back and editing images.

7 Changing Additional Settings

Explains general camera settings and file management settings such as the monitor display settings and the image folder naming system.

8 Connecting to a Computer

Explains how to connect the camera to a computer, and includes installation instructions and a general overview of the provided software.

9 Using the Flash

Explains how to use the built-in flash and external flashes.

10 Appendix

Explains troubleshooting and provides various resources.

1

2

3

4

5

6



7

8

9

10

The symbols used in this Operating Manual are explained below.

	Indicates reference page numbers explaining a related operation.
	Indicates useful information.
	Indicates precautions to take when operating the camera.

In this manual, the arrow keys of the four-way controller are referred to in the following way.

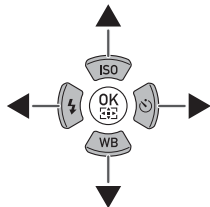

1 Before Using Your Camera

Check the package contents and the names and functions of the working parts before use.

Checking the Contents of the Package	18
Names and Functions of the Working Parts	19
How to Change Function Settings	38

Checking the Contents of the Package

The following accessories are packaged with the camera.
Check that all accessories are included.

1

Before Using Your Camera



Hot shoe cover F_K
(installed on camera)



Eyecup F_R
(installed on camera)



Body mount cover
(installed on camera)



Strap
O-ST132



Rechargeable lithium-ion
battery D-L1109

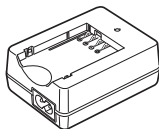

Battery charger
D-BC109



AC plug cord

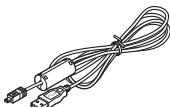

USB cable
I-USB7



Software (CD-ROM)
S-SW138



Operating Manual
(this manual)

Names and Functions of the Working Parts

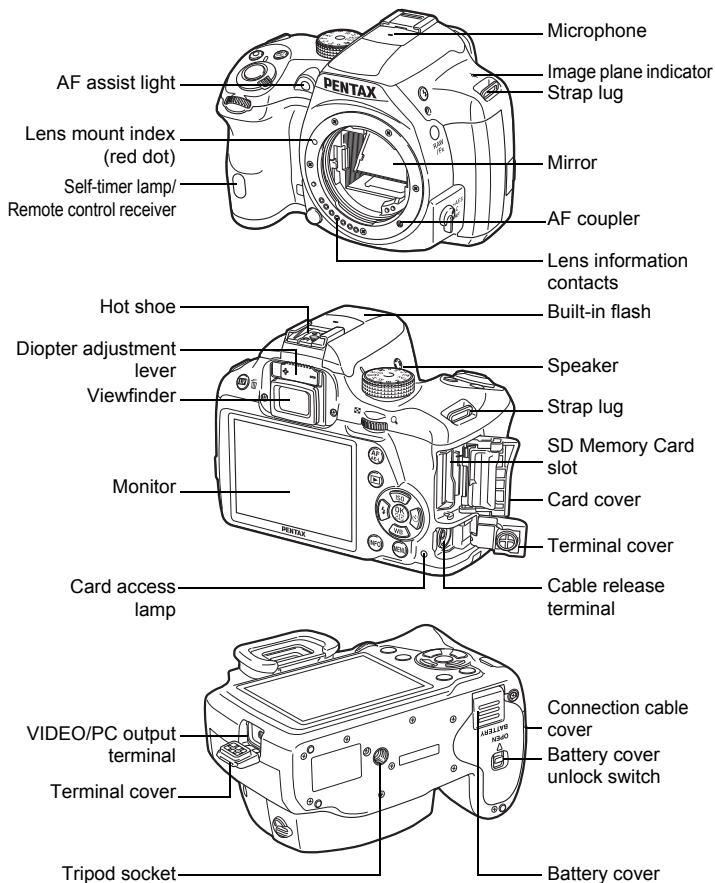

* In the second illustration, the camera is shown with the Hot shoe cover Fk and the Eyecup FR removed.



If the terminal covers and the connection cable cover are not closed correctly, the dust-proof and water-resistant qualities of the camera will not be effective.

Capture Mode

Here, you can learn which parts are used and how they function when in capture mode.



The factory default setting of each part is explained here, but some parts have multiple functions and work differently depending on the selected setting.

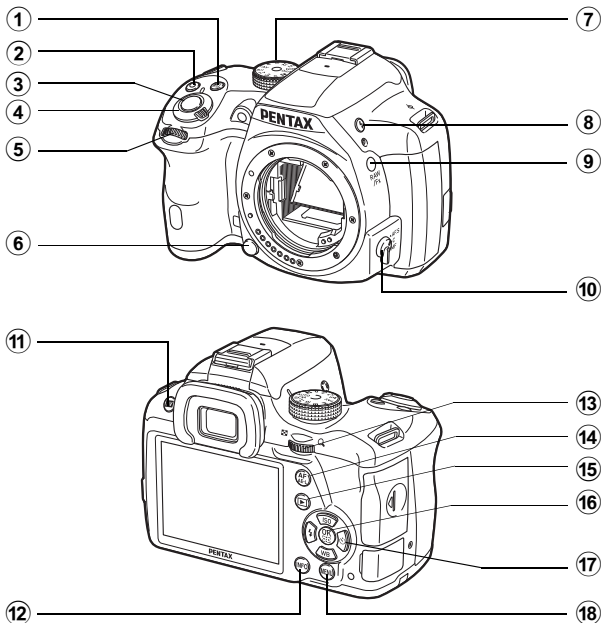

① **☒ (EV Compensation) button**

Press to set the EV compensation value. (p.92)

Turn the rear e-dial (☒) after or while pressing the ☒ button to change the setting.

② **⊙ (Green) button**

Press to reset the values being adjusted.

③ **Shutter release button**

Press to capture images. (p.66)

④ **Main switch**

Move to turn the camera on and off. (p.57)

- ⑤ **Front e-dial** (☀️)
Changes the set value.
You can change the menu when a menu screen is displayed. (p.41)
- ⑥ **Lens unlock button**
Press to detach a lens. (p.55)
- ⑦ **Mode dial**
Changes the capture mode.
(p.82)
- ⑧ **⚡ (Flash pop-up) button**
Press to pop up the built-in flash. (p.71)
- ⑨ **RAW/Fx button**
You can assign a function to this button. (p.167)
- ⑩ **Focus mode switch**
Changes the focus mode.
(p.101)
- ⑪ **LV/🗑️ (Live View) button**
Displays the Live View image.
(p.26)
Deletes the image during Instant Review. (p.66)
- ⑫ **INFO button**
Displays the control panel.
(p.28) Press again to change the type of information displayed in standby mode.
(p.29)
- ⑬ **Rear e-dial** (☀️)
Sets the shutter speed, aperture and EV compensation values. (p.90)
You can change the settings when the control panel is displayed. (p.40)
You can change the menu when a menu screen is displayed. (p.41)
- ⑭ **AF/AE-L button**
You can select the function of this button either to focus on the target or to lock the exposure value. (p.96, p.169)
- ⑮ **▶️ (Playback) button**
Switches to playback mode.
(p.72)
- ⑯ **OK button**
When the control panel or a menu screen is displayed, press this button to confirm the selected item.
When both [AF Active Area] and [Contrast AF] are set to [Select], press this button to enable or disable changing the autofocusing (AF) point or area. (p.105, p.108)
When the camera is in **MF** mode or when the focus is locked during Live View, press this button to magnify the image on the monitor. (p.109)

⑰ Four-way controller (▲▼◀▶)

Displays the Sensitivity/White Balance/Flash Mode/Drive Mode setup menu. (p.76)

When the control panel or a menu screen is displayed, use this to move the cursor or change the item to set.







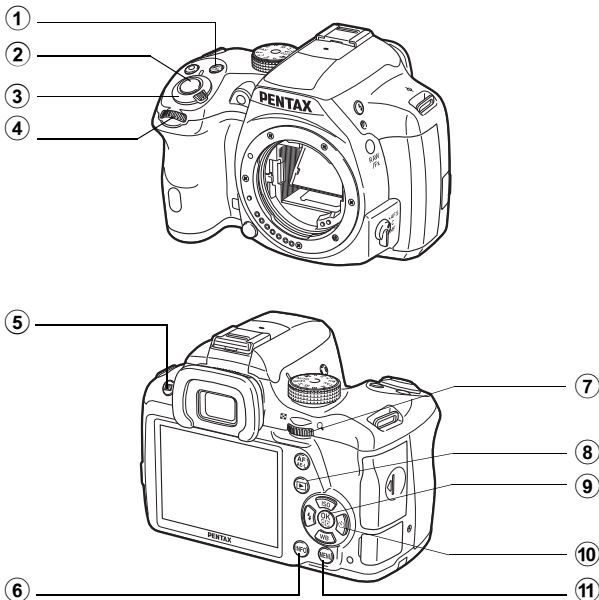

⑱ MENU button

Displays the [📷 Rec. Mode 1] menu (p.77). Press this button when a menu screen is displayed to return to the previous screen. (p.40)

Playback Mode

Here, you can learn which parts are used and how they function when in playback mode.



- ① ** (EV Compensation) button**
When the file format of the last captured image is JPEG, and its data still remains in the buffer memory, press this button to save the image in RAW format. (p.72)
- ② **Shutter release button**
Press halfway to switch to capture mode.
- ③ **Main switch**
Move to turn the camera on and off. (p.57)
- ④ **Front e-dial ()**
Use this to display the next or previous image. (p.72)
- ⑤ ** /  (Delete) button**
Press to delete images. (p.73)
- ⑥ **INFO button**
Changes the type of information displayed in playback mode. (p.30)
- ⑦ **Rear e-dial ()**
Use this to magnify an image or display multiple images at the same time (p.179, p.180).
- ⑧ ** (Playback) button**
Switches to capture mode.
- ⑨ **OK button**
Confirms the setting you selected in the menu or playback screen.
- ⑩ **Four-way controller ()**
Use this to move the cursor or change the item to set in the menu or playback screen. Press the four-way controller () in the single image display to display the playback mode palette. (p.176)
- ⑪ **MENU button**
Displays the [ Playback 1] menu (p.177).

Monitor Display

Various information appears on the monitor depending on the status of the camera.



The brightness level and the color of the monitor can be adjusted. (p.213)

Capture Mode

With this camera, you can take pictures while looking through the viewfinder or while viewing the image on the monitor.

When using the viewfinder, check the status screen displayed on the monitor and the viewfinder indicators while shooting. When not using the viewfinder, display the Live View image on the monitor while shooting.

The camera is in “standby mode” when the status screen or the Live View image is displayed. Press the **INFO** button in standby mode to display the “control panel” and change settings. (p.28)

If you press the **INFO** button while the control panel is displayed, you can select the type of information displayed in standby mode. (p.29)



Standby mode
(status screen)



Control panel

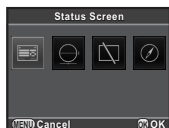

Shooting Info Display
selection screen

● Status screen

The settings for shooting with the viewfinder are displayed.

(All items are displayed here for explanatory purposes. The actual display may differ.)

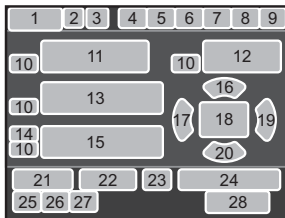

- | | | | |
|----|--|----|---|
| 1 | Capture mode (p.82) | 16 | Sensitivity (p.87) |
| 2 | AE Lock (p.96) | 17 | Flash Mode (p.68) |
| 3 | GPS positioning status | 18 | AF point (p.104) |
| 4 | Custom Image (p.157) | 19 | Drive Mode (p.76) |
| 5 | HDR Capture (p.151)/
Digital Filter (p.161) | 20 | White Balance (p.145) |
| 6 | Focus mode (p.101) | 21 | Flash Exposure Compensation
(p.70) |
| 7 | AE Metering (p.97) | 22 | White Balance fine-tuning (p.146) |
| 8 | Shake Reduction (p.116)/
Horizon Correction (p.118) | 23 | Eye-Fi communication status
(p.228) |
| 9 | Battery level (p.49) | 24 | Number of shots during Interval
Shooting or Multi-exposure |
| 10 | Front/rear e-dial guide | 25 | File Format (p.143) |
| 11 | Shutter speed | 26 | JPEG Recorded Pixels (p.143) |
| 12 | Aperture value | 27 | JPEG Quality (p.144) |
| 13 | Sensitivity (p.87) | 28 | Number of recordable still
pictures/☉ button guide |
| 14 | EV Compensation (p.92)/
Exposure Bracketing (p.93) | | |
| 15 | EV bar scale | | |

* Indicator 3 appears only when the optional GPS unit is attached to the camera and is operating. (p.269)

* Indicator 23 appears only when the Eye-Fi card is in use. 📶 indicates that Eye-Fi communication is in standby mode, 📶 indicates that Eye-Fi is not connected, and the icon is animated during Eye-Fi communication.



The status screen will disappear if no operations are made within 30 seconds, and will also disappear after 2 seconds, immediately after shooting. Press the **INFO** button to display it again.

● Live View

Live View is displayed when the **LV**/ button is pressed. You can capture images while checking the composition on the monitor.

(All items are displayed here for explanatory purposes. The actual display may differ.)

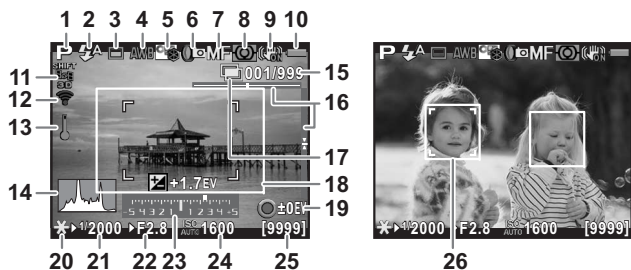

- | | | | |
|----|---|----|---|
| 1 | Capture mode (p.82) | 13 | Temperature warning |
| 2 | Flash Mode (p.68)/
Recording Sound Level (p.131) | 14 | Histogram (p.33) |
| 3 | Drive Mode (p.76) | 15 | Number of shots during Interval
Shooting or Multi-exposure |
| 4 | White Balance (p.145) | 16 | Electronic Level |
| 5 | Custom Image (p.157) | 17 | Interval Shooting (p.125)/
Multi-exposure (p.128) |
| 6 | HDR Capture (p.151)/
Digital Filter (p.161) | 18 | AF frame |
| 7 | Focus mode (p.101) | 19 | ⊙ button guide |
| 8 | AE Metering (p.97) | 20 | AE Lock (p.96) |
| 9 | Shake Reduction (p.116)/
Horizon Correction (p.118)/
Movie SR (p.131) | 21 | Shutter speed |
| 10 | Battery level (p.49) | 22 | Aperture value |
| 11 | GPS positioning status | 23 | EV bar scale |
| 12 | Eye-Fi communication status
(p.228) | 24 | Sensitivity (p.87) |
| | | 25 | Number of recordable still
pictures/movie recordable time |
| | | 26 | Face detection frame |

* Indicator 11 appears only when the optional GPS unit is attached to the camera and is operating. (p.269)

* Indicator 12 appears only when the Eye-Fi card is in use. indicates that Eye-Fi communication is in standby mode, indicates that Eye-Fi is not connected, and the icon is animated during Eye-Fi communication.

* Indicator 16 is displayed when Electronic Level is activated. (p.212)

* Indicator 18 is displayed in white. It turns green when the subject is in focus and turns red when the subject is not in focus. It is not displayed when the focus mode switch is set to **MF**. (p.67)

- * For indicator 26, multiple face detection frames are displayed when [Contrast AF] is set to [Face Detection]. A main face detection frame is displayed in yellow and other frames in white. (p.106)



- The Live View image may differ from the actual image captured if the brightness of the subject is low or high.
- If any changes occur in the shooting light source during Live View, the image on the monitor may flicker. You can cut down on flicker by setting the power frequency in [Flicker Reduction] of the [Set-up 2] menu to that used in your region.
- If the camera position is changed rapidly during Live View, the image may not be displayed with the appropriate brightness. Wait for the display to become stable before shooting.
- Noise may appear on the Live View image when used in dark locations.
- The higher the sensitivity, the more noise and color unevenness may occur in the monitor image and/or captured image.
- If you continue shooting for a prolonged period, the internal temperature of the camera may increase, resulting in lower quality images. It is recommended that you turn off the camera when not shooting. To prevent the image quality from degrading, allow enough time for the camera to cool down while shooting with long exposures or recording movies.
- If the internal temperature of the camera becomes high, (temperature warning) is displayed and Live View may not be available. If this happens, stop shooting or use the viewfinder.



You can change the Live View display settings in [Live View] of the [Rec. Mode 4] menu. (p.107)

● Control panel

Press the **INFO** button in standby mode to display the control panel and change settings. (p.39)

Still picture capture mode

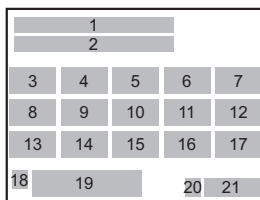
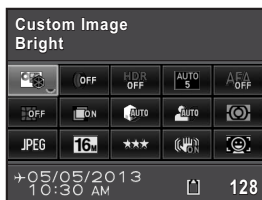

mode

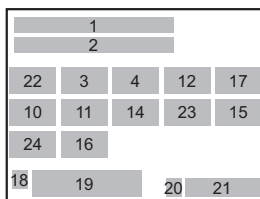

- 1 Function name
- 2 Setting
- 3 Custom Image (p.157)/
SCN mode (p.84)
- 4 Digital Filter (p.161)
- 5 HDR Capture (p.151)
- 6 AF Active Area (p.104)
- 7 AF.A (p.103)
- 8 Distortion Correction (p.153)
- 9 Lateral Chromatic Aberration
Adjustment (p.153)
- 10 Highlight Correction (p.150)
- 11 Shadow Correction (p.150)
- 12 AE Metering (p.97)
- 13 File Format (p.143)
- 14 JPEG Recorded Pixels (p.143)/
Movie Recorded Pixels (p.131)
- 15 JPEG Quality (p.144)/
Movie Quality Level (p.131)
- 16 Shake Reduction (p.116)/
Movie SR (p.131)
- 17 Contrast AF (p.106)
- 18 Destination setting (p.209)
- 19 Current date and time (p.60)
- 20 SD Memory Card status
- 21 Number of recordable still
pictures/movie recordable time
- 22 Exposure Setting (p.130)
- 23 Framerate (p.131)
- 24 Recording Sound Level (p.131)



- If no operations are made within 1 minute in the control panel, the camera returns to standby mode.
- You can change the display color of the status screen and control panel. Set in [LCD Display] of the [Set-up 1] menu. (p.212)

● Shooting Info Display

If you press the **INFO** button while the control panel is displayed, you can select the type of information displayed in standby mode for when shooting with the viewfinder. Use the four-way controller (▲▼◀▶) to select a display type and press the **OK** button.

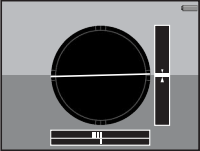
Screen Display	Displayed Information
Status Screen	Displays the settings for shooting with the viewfinder. (p.25)
Electronic Level	<p>Displays the camera angle. A bar scale indicating the horizontal camera angle appears at the bottom of the screen, and a bar scale indicating the vertical camera angle appears on the right side. If the camera angle cannot be detected, both ends and the center of the bar scales flash red.</p> <p>Press the shutter release button halfway to return to the status screen.</p>  <p>Example: Tilted 1.5° to the left (yellow) Vertically level (green)</p>
Display Off	Nothing is displayed on the monitor.
Electronic Compass	The current latitude, longitude, altitude, direction, and Coordinated Universal Time (UTC) are displayed. Press the shutter release button halfway or turn the camera off and on again to return to the status screen. Available only when the optional GPS unit is attached to the camera and is operating. (p.269)



The Shooting Info Display selection screen is not displayed when the mode dial is set to .



- If Electronic Level or Display Off is selected, the display setting returns to the status screen when the camera is turned off and on again. If you select the check box for [Shooting Info Display] in [Memory] of the [Rec. Mode 4] menu, the selected screen display appears the next time the camera is turned on. (p.218)
- The Live View image and the indicators which provide shooting information are displayed during Live View shooting. If you do not want to display the indicators, you can change the setting in [Live View] of the [Rec. Mode 4] menu. (p.107)

● Detailed Information Display

Use the four-way controller (▲▼) to switch between pages.

(All items are displayed here for explanatory purposes. The actual display may differ.)

Page 1

Still picture

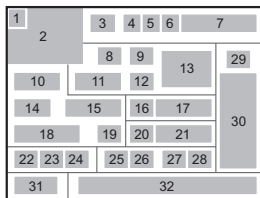

Movie

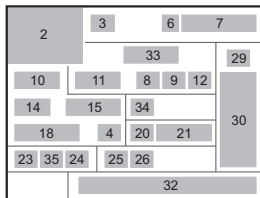

Page 2

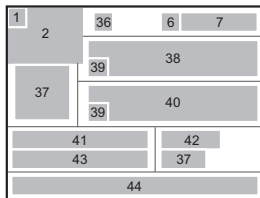

- | | |
|--|--|
| <ul style="list-style-type: none"> 1 Rotation information (p.185) 2 Captured image 3 Capture mode (p.82) 4 Digital Filter (p.161) 5 DPOF setting (p.231) 6 Protect setting (p.222) | <ul style="list-style-type: none"> 7 Folder number-File number 8 Drive Mode (p.76) 9 AE Metering (p.97) 10 Shutter speed 11 Lens focal length |
|--|--|

- | | |
|---|--|
| 12 Shake Reduction (p.116)/
Horizon Correction (p.118)/
Movie SR (p.131) | 26 Shadow Correction (p.150) |
| 13 Focus mode (p.101)/AF point
(p.104)/Contrast AF (p.106) | 27 Distortion Correction (p.153) |
| 14 Aperture value | 28 Lateral Chromatic Aberration
Adjustment (p.153) |
| 15 EV Compensation (p.92) | 29 Custom Image (p.157) |
| 16 Flash Mode (p.68) | 30 Custom Image parameters
(p.158) |
| 17 Flash Exposure Compensation
(p.70) | 31 Color Space (p.144) |
| 18 Sensitivity (p.87) | 32 Shooting date and time |
| 19 HDR Capture (p.151)/
Multi-exposure (p.128) | 33 Recording time |
| 20 White Balance (p.145) | 34 Recording Sound Level (p.131) |
| 21 White Balance fine-tuning (p.146) | 35 Framerate (p.131) |
| 22 File Format (p.143) | 36 Transferred via Eye-Fi (p.228) |
| 23 JPEG Recorded Pixels (p.143)/
Movie Recorded Pixels (p.131) | 37 Lens direction |
| 24 JPEG Quality (p.144)/
Movie Quality Level (p.131) | 38 Photographer (p.227) |
| 25 Highlight Correction (p.150) | 39 Information tampering warning |
| | 40 Copyright Holder (p.227) |
| | 41 Latitude |
| | 42 Altitude |
| | 43 Longitude |
| | 44 Universal Coordinated Time |

* Indicator 36 appears only for images that have been transferred using the Eye-Fi card.

* Indicators 37 and 41 to 44 appear only for images in which GPS information is stored.

● Histogram Display/RGB Histogram Display

Use the four-way controller (▲▼) to switch between the Histogram Display and RGB Histogram Display.

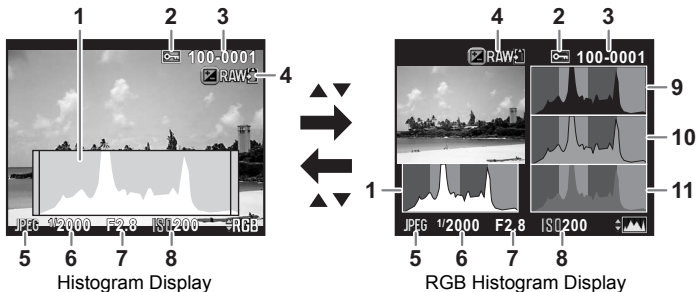

- | | |
|-----------------------------|------------------|
| 1 Histogram (Brightness) | 7 Aperture value |
| 2 Protect setting | 8 Sensitivity |
| 3 Folder number-File number | 9 Histogram (R) |
| 4 Save RAW Data | 10 Histogram (G) |
| 5 File Format | 11 Histogram (B) |
| 6 Shutter speed | |

* Indicator 4 appears only when the file format of the last captured image is JPEG, and the image can also be saved in RAW format. (p.72)

Using the Histogram

A histogram shows the brightness distribution of an image. The horizontal axis represents brightness (dark at the left and bright at the right) and the vertical axis represents the number of pixels.

The shape and the distribution of the histogram before and after shooting tell you whether the exposure level and contrast are correct or not, and let you decide if you need to adjust the exposure and take a picture again.

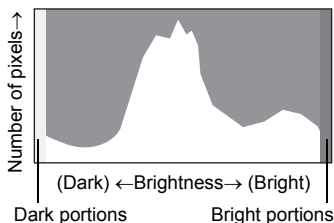

- ☞ Adjusting the Exposure (p.92)
- ☞ Brightness Adjustment (p.150)

When the image is underexposed, the part to the left is cut off (underexposed portions with no detail) and when the image is overexposed, the part to the right is cut off (overexposed portions with no detail).

You can set whether to display the bright/dark area warning during capture or playback mode.

- ☞ Setting the Playback Display Method (p.178)
- ☞ Setting the Display for Instant Review (p.214)















Distribution of color intensity is displayed for each color in RGB Histogram Display. If a color is partially cut off on one side, it indicates that the color is under- or overexposed, that the light is very weak or strong in that color, or that the white balance is incorrect.

- ☞ Setting the White Balance (p.145)

Guide Indicators

The following indicators appear on the monitor to indicate the keys, buttons and e-dials that can be operated at that time.

Example:

	Four-way controller (▲)		○ button
	Four-way controller (▼)		INFO button
	Four-way controller (◀)		☑ button
	Four-way controller (▶)		LV /☒ button
	MENU button		AF/AE-L button
	OK button		RAW/Fx button
	Front e-dial		Shutter release button
	Rear e-dial		

Viewfinder

When shooting with the viewfinder, the following information appears in the viewfinder.

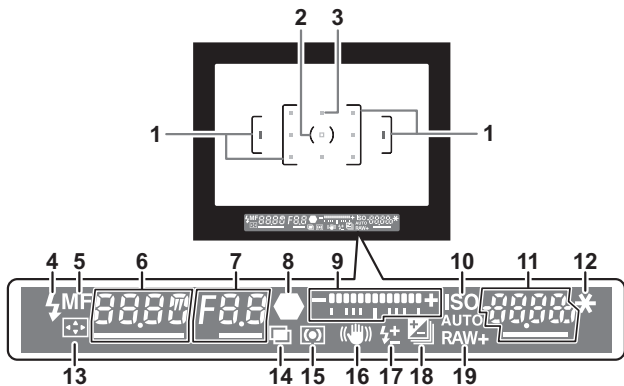

- 1 **AF frame**
- 2 **Spot metering frame** (p.97)
- 3 **AF point** (p.104)
The AF point in use for autofocus appears in red (Superimpose AF Area) when the shutter release button is pressed halfway. (p.104)
- 4 **Flash indicator** (p.71)
Lit: when the flash is available.
Blinks: when the flash is necessary or is being charged.
- 5 **Focus mode** (p.101)
Appears when set to **MF**.
- 6 **Shutter speed**
Underlined when it can be adjusted.
- 7 **Aperture value**
Underlined when it can be adjusted.
- 8 **Focus indicator** (p.65)
Lit: when the subject is in focus.
Blinks: when the subject is not in focus.
- 9 **EV bar scale**
Displays the EV compensation values or difference between the appropriate and current exposure values in **M** mode. (p.90, p.92)
Displays the camera angle when Electronic Level is activated. (p.37)

- 10 **ISO/ISO AUTO** (p.87)
Appears when the sensitivity is displayed.
- 11 **Sensitivity/Remaining image storage capacity**
Underlined when it can be adjusted.
Displays the number of recordable still pictures (up to “9999”) immediately after shooting.
Displays the compensation value while adjusting the EV compensation.
Displays the amount of deviation from the correct exposure when in **M** mode and Electronic Level is activated.
- 12 **AE Lock** (p.96)
Appears while the AE Lock function is activated.
- 13 **Changing AF point** (p.105)
Appears when the AF point can be changed.
- 14 **Multi-exposure** (p.128)
Appears when Multi-exposure is set.
- 15 **AE Metering** (p.97)
Appears when Center-weighted metering or Spot metering is selected.
- 16 **Shake Reduction** (p.116)
Appears when the Shake Reduction function is activated.
- 17 **Flash Exposure Compensation** (p.70)
Appears when the flash exposure compensation value is being adjusted.
- 18 **EV Compensation** (p.92)/**Exposure Bracketing** (p.93)
Appears when adjusting the EV compensation or when Exposure Bracketing is set.
- 19 **File Format** (p.143)
Appears when the file format is RAW or RAW+.



The information is displayed in the viewfinder when the shutter release button is pressed halfway, or during the meter operating time (default setting: 10 sec.). (p.97)

● Electronic Level Display

When the camera is not level, a bar scale indicating the horizontal camera angle is displayed in the EV bar scale, if [Electronic Level] of the [📷 Rec. Mode 3] menu is activated. This is not active by default. (p.212)

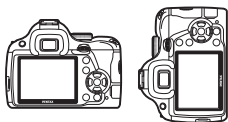

When level (at 0°)



When tilted 5° to the left



When held vertically and tilted 3° to the right



Function settings can be changed using the direct keys, control panel or menus.

This section explains the basic ways to change function settings.

1

Before Using Your Camera

Using the Direct Keys

In standby mode, you can set Sensitivity, White Balance, Flash Mode and Drive Mode by pressing the four-way controller (▲▼◀▶). (p.76)
Below, how to set [Flash Mode] is explained as an example.

- 1 Press the four-way controller (◀) in standby mode.**

The Flash Mode setting screen appears.

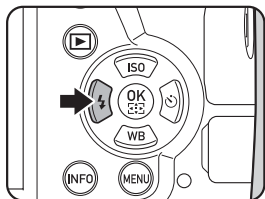

- 2 Use the four-way controller (◀▶) to select a flash mode.**

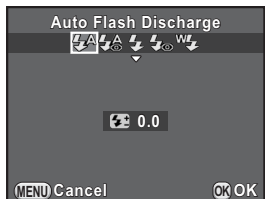

- 3 Press the OK button.**

The camera is ready to take a picture.

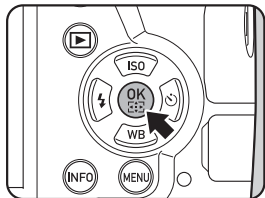

Using the Control Panel

In standby mode, you can switch to the control panel and change settings. Below, how to set [JPEG Quality] is explained as an example.

1

Before Using Your Camera

1 Press the INFO button in standby mode.

The control panel appears.

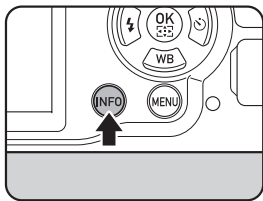

2 Use the four-way controller (▲▼◀▶) to select the item you want to change the setting for.

You cannot select items that cannot be changed as a result of current camera settings.

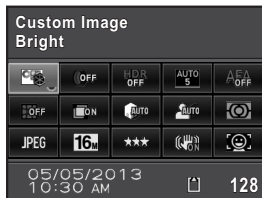

3 Press the OK button.

The setup screen of the selected item appears.



4 Use the four-way controller (◀▶) or rear e-dial (☀) to select a setting value.

Items not available with the current camera settings cannot be selected.



5 Press the OK button.

The camera returns to the control panel.
Next, set other items.

6 Press the MENU button or the shutter release button halfway.

The camera is ready to take a picture.



You can also change the setting by turning the rear e-dial (☀️) after selecting the item you want to change in Step 2 ([Recording Sound Level] for 📹 mode can only be set using this operation). Detailed settings such as for Custom Image and Digital Filter can be changed after pressing the **OK** button.

Using the Menus

This section explains how to use the following menus: [📷 Rec. Mode], [📹 Movie], [▶ Playback], [⚙ Set-up] and [Ⓒ Custom Setting].
Below, how to set [Slow Shutter Speed NR] in the [📷 Rec. Mode 3] menu is explained as an example.

1 Press the MENU button in standby mode.

The [📷 Rec. Mode 1] menu appears on the monitor.

The menus listed below are displayed in the following situations.

When the mode dial is set to 📹	[📹 Movie 1] menu
In playback mode	[▶ Playback 1] menu

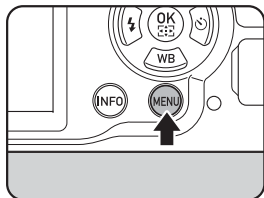

2 Press the four-way controller (▶) twice.

Each time the four-way controller (▶) is pressed, the menu will change in the following sequence: [📷 Rec. Mode 2], [📷 Rec. Mode 3], [📷 Rec. Mode 4], [🎞️ Movie 1] ... [📷 Rec. Mode 1].

You can also change the menu by turning the rear e-dial (☀️).

When the front e-dial (☀️) is turned to the right, the menu will change in the following sequence: [📷 Rec. Mode 1], [🎞️ Movie 1], [▶ Playback 1], [⚙️ Set-up 1], [C Custom Setting 1].

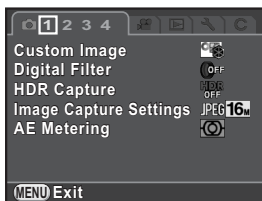

3 Use the four-way controller (▲▼) to select an item.

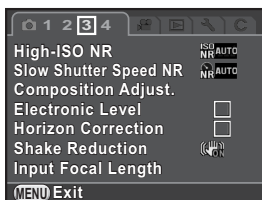

4 Press the four-way controller (▶).

Available settings are displayed in the pop-up menu or submenu.

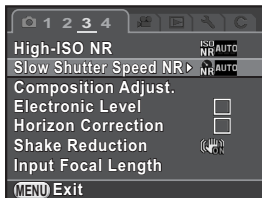

5 Use the four-way controller (▲▼) to select a setting.

Press the **MENU** button to cancel the pop-up menu, or return to the previous screen.

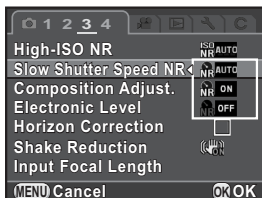

6 Press the OK button.

The setting is saved.

Press the **MENU** button if a submenu is displayed.

Next, set other items.

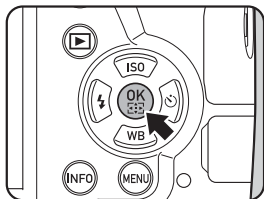

7 Press the MENU button.

The screen that was displayed before selecting the menu item appears again.

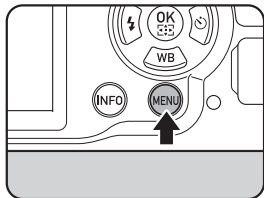

Your settings may not be saved if the camera is turned off improperly (such as by removing the battery while the camera is on).



- You can select either to display the menu tab selected the last time first, or to always display the [📷 Rec. Mode 1] menu first. (p.215)
- Refer to the following pages for details on each menu.
 - [📷 Rec. Mode] menu ☞ p.77
 - [🎬 Movie] menu ☞ p.79
 - [▶ Playback] menu ☞ p.177
 - [⚙️ Set-up] menu ☞ p.206
 - [C Custom Setting] menu ☞ p.80

2 Getting Started

This chapter explains your first steps from purchasing the camera to taking pictures. Be sure to read this and follow the instructions.

Attaching the Strap	44
Inserting the Battery	45
Inserting/Removing an SD Memory Card	52
Attaching a Lens	54
Adjusting the Viewfinder Diopter	56
Turning the Camera On and Off	57
Initial Settings	58

Attaching the Strap

- 1** Pass the end of the strap through the strap lug, then secure it on the inside of the clasp.

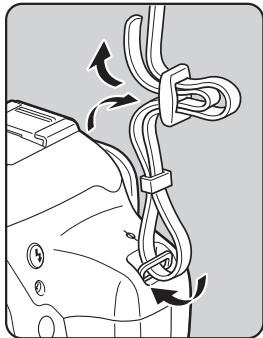

- 2** Attach the other end of the strap in the same manner as described above.

The following power supplies can be used with the camera.

- Rechargeable Lithium-ion Battery D-LI109 (provided)
- AA Battery Holder D-BH109 with four AA batteries (optional)
- AC Adapter Kit K-AC128 (optional)

Using the Lithium-ion Battery

Use the battery charger D-BC109 and the rechargeable lithium-ion battery D-LI109 to power the camera.

Charging the Battery

When using the battery for the first time or when the battery capacity becomes low, recharge the battery.

Note: AC plug cord “Listed, Type SPT-2 or NISPT-2, 18/2 flexible cord, rated 125 V, 7A, minimum 6ft (1.8m)”

1 Connect the AC plug cord to the battery charger.

2 Plug the AC plug cord into the power outlet.

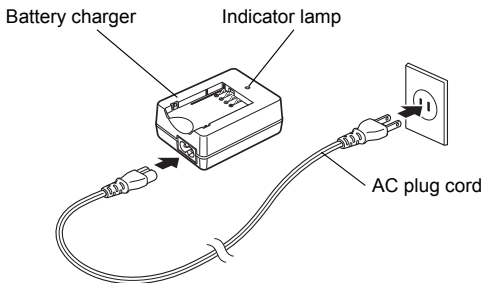

3 Face the ▲ mark on the battery up, and insert the battery into the battery charger.

First, insert the battery at an angle, as shown in the illustration, and then push down on the battery until it clicks.

The indicator lamp lights up when charging and turns off when the battery is fully charged.

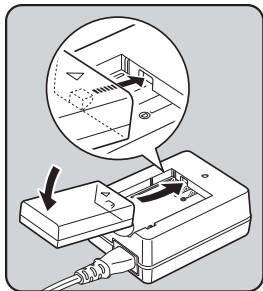

4 When the battery is fully charged, remove the battery from the battery charger.



- Do not use the Battery Charger D-BC109 to charge batteries other than D-LI109. Charging other batteries may cause damage or heating.
- Replace the battery with a new one in the following cases:
 - If the indicator lamp blinks or does not light after the battery is inserted correctly
 - If the battery starts to run down more quickly even after being charged (the battery may have reached the end of its service life)



The maximum charging time is approximately 240 minutes (depends on temperature and remaining battery power). Charge in a location where the temperature is between 0°C and 40°C.

Inserting/Removing the Battery



- Do not open the battery cover or remove the battery while the power is on.
- Insert the battery correctly. If the battery is inserted incorrectly, it may not be removed. Wipe the electrodes of the battery with a soft dry cloth before inserting.
- Be careful as the camera or battery may become hot when the camera is used continuously for a long period of time.
- Remove the battery when you will not use the camera for a long while. The battery may leak and damage the camera if left installed during prolonged periods of non-use. If the removed battery will not be used for six months or longer, charge the battery for about 30 minutes before storing it. Be sure to recharge the battery every six to twelve months.
- Store the battery in a location where the temperature will remain below room temperature. Avoid locations with high temperatures.
- The date and time may be reset if you leave the battery out of the camera for a long period of time. If this occurs, follow the procedure described in "Setting the Date and Time" (p.60) to set the current date and time.

- 1** Slide the battery cover unlock switch in the direction of the arrow (1), and open the battery cover (2).

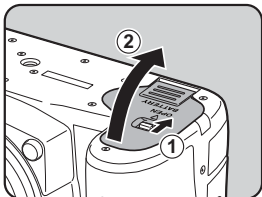

- 2** With the ▲ mark facing towards outside of the camera, push the battery in until it locks into place.

To remove the battery, push the battery lock switch in the direction of the arrow (3).

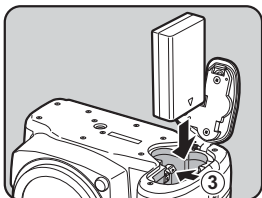

3 Close the battery cover.

The battery cover is locked.

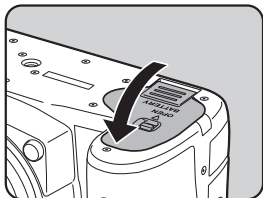

Using the AA Batteries

When using AA batteries, be sure to use the optional AA Battery Holder D-BH109.

Use four AA lithium batteries, AA Ni-MH rechargeable batteries, or AA alkaline batteries.

Available Batteries	Characteristics
AA lithium batteries	Recommended when using the camera in cold climates.
AA Ni-MH rechargeable batteries	These are rechargeable and reusable. A battery charger that is compatible with the batteries is required.
AA alkaline batteries	These are easily obtainable when the batteries you are using run out but they may not support all the camera functions under certain conditions. Use them in emergencies or when checking the camera functionality.



- For precautions when using the batteries, refer to “About the Usage of AA Batteries” (p.3).
- If AA Ni-MH rechargeable batteries with a capacity of approximately 1000 mAh are used, the batteries may not last for very long. Use Ni-MH rechargeable batteries with a large capacity.

1 Insert the AA batteries according to the +/- indicators on the battery holder.

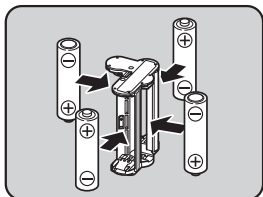

2 Open the battery cover.

Refer to Step 1 on p.47.

Remove the battery if it is inserted in the camera.





3 Insert the battery holder into the battery chamber until it locks into place, and close the battery cover.





- To use the AA batteries, set the AA battery type in [AA Battery Type] of the [↖ Set-up 3] menu before use. (p.216)
- Check the orientation of the batteries if the camera does not operate properly.

Battery Level Indicator

You can confirm remaining battery level by checking the  displayed in the status screen or Live View screen.

Display	Battery Level
 (green)	Battery is full.
 (green)	Battery is close to full. (D-LI109 only)
 (orange)	Battery is running low. (D-BH109 only)
 (yellow)	Battery is running low. (D-LI109 only)
 (red)	Battery is almost empty.
[Battery depleted]	The camera turns off after displaying the message.



- ,  or  (red) may appear even when the battery level is sufficient if the camera is used at low temperatures or when performing continuous shooting for a long period of time.
- Battery performance temporarily decreases as the temperature decreases. When using the camera in cold climates, have extra batteries at hand and keep them warm in your pocket. The battery performance will return to normal at room temperature.
- Have extra batteries ready when traveling abroad, or taking a lot of pictures.

Using the AC Adapter

We recommend the use of the optional AC adapter kit K-AC128 when using the monitor for a long time or when connecting the camera to a computer or AV device.



The AC Adapter Kit K-AC128 includes AC Adapter D-AC120, DC Coupler D-DC128, and AC plug cord.

1 Make sure that the camera is turned off.

2 Open the battery cover.

Refer to Step 1 on p.47.

Remove the battery if it is inserted in the camera.

3 Pull out the connection cable cover (1) on the right of the battery cover, and insert the DC coupler into the battery chamber until it locks into place.

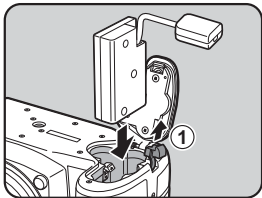

4 Close the battery cover.

The connection cable is pulled out from the connection cable cover section.

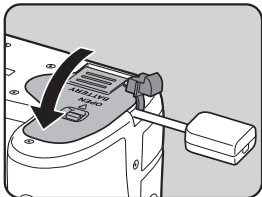

5 Connect the DC coupler and the AC adapter.

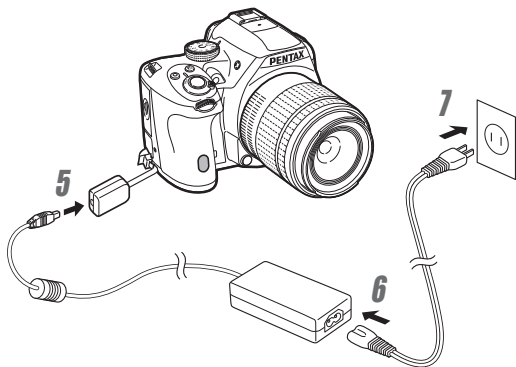

6 Connect the AC adapter to the AC plug cord.

7 Plug the AC plug cord into the power outlet.



- Make sure the camera is turned off before connecting or disconnecting the AC adapter.
- Make sure connections are secure between the terminals. SD Memory Card or data may be corrupted if the connection to the power supply is lost while the card is being accessed.
- The connection cable will protrude from the connection cable cover on the camera while the AC adapter is in use.
- After removing the DC coupler, return the connection cable cover to its original position.



- When the AC adapter is connected to the camera, **DCIM** is displayed for the battery level indicator.
- Be sure to read the manual of the AC adapter kit before using the AC adapter.

Inserting/Removing an SD Memory Card

This camera uses a commercially available SD Memory Card, SDHC Memory Card, or SDXC Memory Card.

Make sure the camera is turned off before inserting or removing the SD Memory Card.

2

Getting Started

Caution:

- Do not remove the SD Memory Card while the card access lamp is lit.
- Do not open the card cover while the camera is in use.
- Use this camera to format (initialize) an SD Memory Card that is unused or has been used on other devices. Refer to "Formatting an SD Memory Card" (p.221) for details on formatting.
- Use a high-speed memory card when recording movies. If the writing speed cannot keep up with the recording speed, writing may stop during recording.

1 Make sure that the camera is turned off.

2 Slide the card cover in the direction of the arrow, and then lift it to open (①→②).

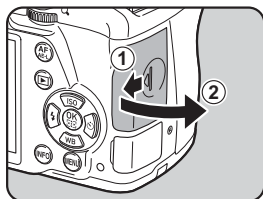

3 Insert the card all the way with the SD Memory Card label facing toward the monitor.

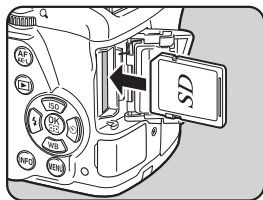

Push the SD Memory Card in once to remove.

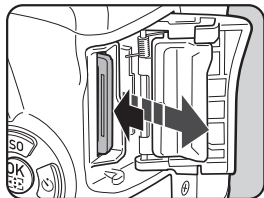

- 4** Close the card cover (③), and then slide it in the direction of the arrow (④).

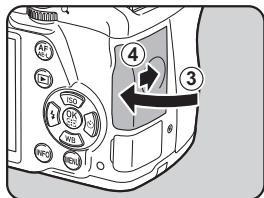

Be sure to fully close the card cover. The camera will not turn on if the card cover is open.



For details on the approximate number of still pictures and amount of time of movies that can be recorded on an SD Memory Card, refer to "Approximate Image Storage Capacity by Size" (p.284).

Attach a proper lens to the camera body.

When you use one of the following lenses with this camera, all the camera's capture modes are available.

- (a) DA, DA L, D FA, FA J lenses
- (b) Lenses with an **A** (Auto) position; when used in the **A** position



- When attaching or removing a lens, choose an environment that is relatively free of dirt and dust.
- Keep the body mount cover on the camera when a lens is not attached.
- Be sure to attach the lens mount cover and lens cap to the lens after removing the lens from the camera.
- Do not insert any fingers into the camera mount or touch the mirror.
- The camera body and lens mount incorporate lens information contacts. Dirt, dust, or corrosion on the contacts may damage the electrical system. Please contact a PENTAX Service Center for professional cleaning.
- Some functions will be restricted when one of lenses described in (b) is used with the aperture ring set to the position other than **A**, or when a lens other than listed above and/or other accessories are used. Refer to "Functions Available with Various Lens Combinations" (p.261) for details.
- If a lens for which the focal length information cannot be automatically obtained is used, the [Input Focal Length] screen appears when the camera is turned on. Refer to "Setting the Focal Length" (p.264) for details.
- We assume no responsibility nor liability for accidents, damages and malfunctions resulting from the use of lenses made by other manufacturers.

1 Make sure that the camera is turned off.

2 Remove the body mount cover (1) and lens mount cover (2).

Be sure to put the lens down with the lens mount side facing upward to protect the lens mount from damage when there is no lens mount cover on the lens.

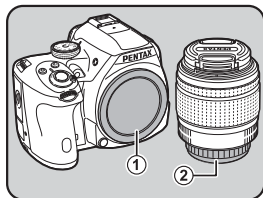

- 3** Align the lens mount index (red dots: ③) on the camera and the lens, and secure by turning the lens clockwise until it clicks.

After attaching, turn the lens counterclockwise to make sure that the lens is locked in place.

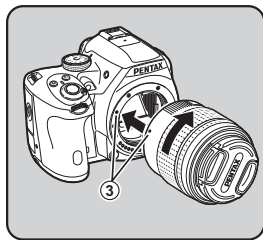

- 4** Remove the front lens cap by pushing the indicated portions inward.

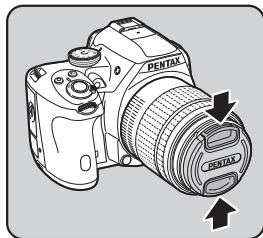

To remove the lens

Attach the lens cap first, and then turn the lens counterclockwise while holding down the lens unlock button (④).

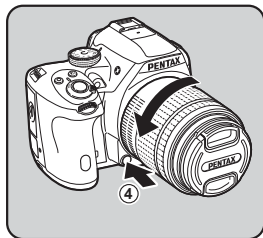

The body mount cover (①) is for preventing scratches and blocking dust when shipped. Body Mount Cap K that has a lock on the body is sold separately.

Adjusting the Viewfinder Diopter

You can adjust the viewfinder diopter to suit your eyesight. The Eyecup F_R is attached to the viewfinder portion when the camera leaves the factory. The diopter can be adjusted with the eyecup attached. However, adjustment is easier with the eyecup removed.

- 1** Remove the eyecup by pulling it out in the direction of the arrow.

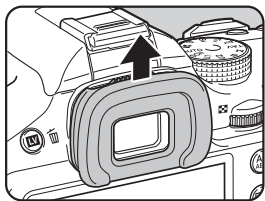

- 2** Look through the viewfinder, and slide the diopter adjustment lever left or right.

Adjust the lever until the AF frame in the viewfinder is focused.

Point the camera at a white wall or other bright and consistent surface.

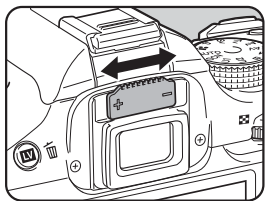

AF frame

- 3** Align the eyecup with the groove on the viewfinder eyepiece and push it into the position.





You can also use the optional Magnifier Eyecup O-ME53 for more precise focusing.

1 Turn the main switch to [ON].

The camera turns on.

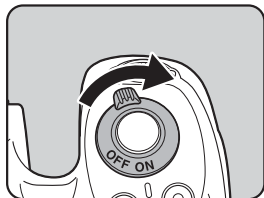
Set the main switch to the position [OFF] to turn off the camera.



- Always turn the camera off when not in use.
- The power will automatically turn off when you do not perform any operations within a set period of time (Auto Power Off). To reactivate the camera, turn it on again or perform any of the following operations.
 - Press the shutter release button halfway.
 - Press the **MENU** button or **INFO** button.
- [Auto Power Off] is set to [1min.] by default. You can change the setting in [Auto Power Off] of the [↖ Set-up 3] menu. (p.216)
- To turn the camera on in playback mode, turn the main switch to [ON] while holding down the  button.

The first time the camera is turned on, the [Language/言語] screen appears on the monitor. Follow the procedure below to set the language displayed on the monitor and the current date and time.

If the [Date Adjustment] screen appears, proceed to “Setting the Date and Time” (p.60).

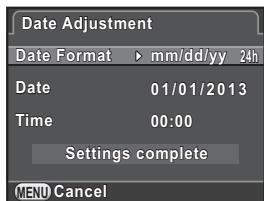

Setting the Display Language

You can set the language in which the menus, error messages, etc. are displayed.

- 1 Use the four-way controller (▲▼◀▶) to select the desired language, and press the OK button.**

The [Initial Setting] screen appears in the selected language.

Proceed to Step 6 if 🏠 (Hometown) does not have to be changed.

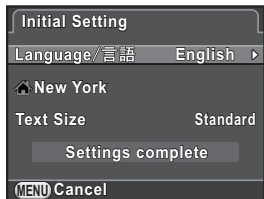

- 2 Press the four-way controller (▼) to move the frame to 🏠, and press the four-way controller (▶).**

The [🏠 Hometown] screen appears.

3 Use the four-way controller (◀▶) to select a city.

Turn the rear e-dial (🔍) to change the region.

Refer to “List of World Time Cities” (p.211) for cities that can be selected as a hometown.



4 Press the four-way controller (▼) to select [DST], and use the four-way controller (◀▶) to select (On) or (Off).

5 Press the OK button.

The [Initial Setting] screen reappears.

6 Press the four-way controller (▼) to select [Text Size], and press the four-way controller (▶).

7 Use the four-way controller (▲▼) to select [Standard] or [Large], and press the OK button.

Selecting [Large] increases the text size of the selected menu items.



8 Press the four-way controller (▼) to select [Settings complete], and press the OK button.

The [Date Adjustment] screen appears.



- If the hometown and the date and time are not set, the [Initial Setting] screen or [Date Adjustment] screen will be displayed again the next time the camera is turned on.
- You can change the text size from the [🔍 Set-up 1] menu later. In this manual, the menu screens hereafter are described with [Text Size] set to [Standard].

Setting the Date and Time

Set the current date and time and the display style.

- 1 Press the four-way controller (▶), and use the four-way controller (▲▼) to select the date format.

Choose [mm/dd/yy], [dd/mm/yy] or [yy/mm/dd].

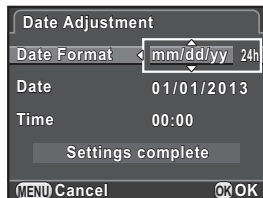

- 2 Press the four-way controller (▶), and use the four-way controller (▲▼) to select [24h] or [12h].

- 3 Press the OK button.

The frame returns to [Date Format].

- 4 Press the four-way controller (▼), and press the four-way controller (▶).

The frame moves to the month if the date format is set to [mm/dd/yy].

- 5 Use the four-way controller (▲▼) to set the month.

Set the day and year in the same manner. Next, set the time.

If you select [12h] in Step 2, the camera switches between am and pm depending on the time.

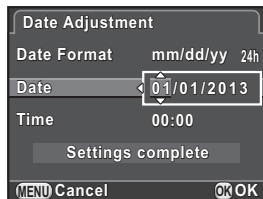

6 Press the four-way controller (▼) to select [Settings complete], and press the OK button.

The camera is ready to take a picture.

If you set the date and time from the menu, the [Set-up 1] menu reappears.

In this case, press the **MENU** button.

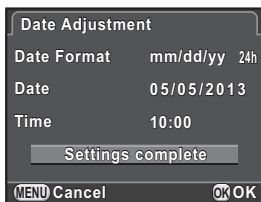

- When you press the **OK** button in Step 6, the seconds value is set to 0. To set the exact time, press the **OK** button when the time signal (on the TV, radio, etc.) reaches 0 seconds.
- Pressing the **MENU** button while setting the date and time cancels the settings made up to that point and switches the camera to capture mode.
- You can change the language and date and time settings from the [Set-up 1] menu later.

Memo

3 Basic Operations

This chapter explains basic operations for shooting by setting the mode dial to **AUTO** (Auto Picture) to have the camera select the optimum settings based on the subject. For information about advanced functions and settings for taking pictures, refer to chapter 4 and onward.

Basic Shooting Operation	64
Using the Built-in Flash	68
Reviewing Images	72

Letting the Camera Choose the Optimal Settings

This camera features various capture modes, focus modes, and drive modes. This section explains how to take pictures by simply pressing the shutter release button.

You can take pictures while looking through the viewfinder or while viewing the image on the monitor.

Taking Pictures Using the Viewfinder

1 Set the mode dial to **AUTO**.

The capture mode is set to **AUTO** mode.

- ☛ Selecting the Appropriate Capture Mode (p.82)

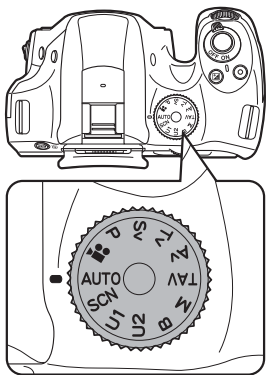

2 Set the focus mode switch to A.F.S.

In **AUTO** mode, the focus mode changes to **A.F.A** (Autofocus/Auto) mode.

☞ Setting the Focus Mode (p.101)

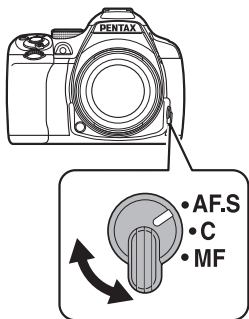

3 Look through the viewfinder to view the subject.



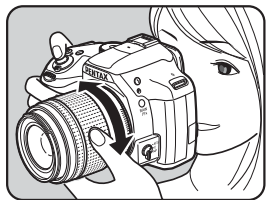





When using a zoom lens, turn the zoom ring to the right or left to change the angle of view.





4 Position the subject inside the AF frame, and press the shutter release button halfway.

The autofocus system operates.

The focus indicator  appears and you will hear a beep when the subject comes into focus (focus lock).

When set to **AUTO** mode, the optimal capture mode is automatically selected from  (Standard),  (Portrait),  (Landscape),  (Macro),  (Moving Object),  (Night Scene Portrait),  (Sunset),  (Blue Sky) or  (Forest). (p.83)

The AF assist light turns on in a dark or backlit location. If the flash is necessary, the flash status  blinks in the viewfinder. Press the  button to pop up the flash.

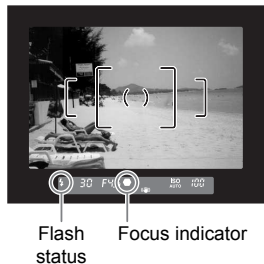

5 Press the shutter release button fully.

The picture is taken.

This action is referred to as “releasing the shutter” or “release”.

6 Review the captured image on the monitor.

The image appears for 1 second on the monitor shortly after it is captured (Instant Review).

The following operations can be performed during Instant Review.

Available operations

button	Deletes the image. (p.73)
Rear e-dial ()	Magnifies the image. (p.179)
button	Saves the RAW image (only when the data is available). (p.72)

Setting the Display for Instant Review (p.214)



- The beep that sounds when the image is focused can be turned off. (p.208)
- You can set the camera so that it automatically focuses when the **AF/AE-L** button is pressed. (p.169)
- You can preview the image on the monitor and check the depth of field before shooting. (p.114)



Power zoom functions (Image Size Tracking, Zoom Clip and Auto Zoom Effect) are not available with this camera. Use manual zoom.

Taking Pictures Using Live View

1 Press the **LV/** button in Step 3 on p.65.

The Live View image is displayed on the monitor.

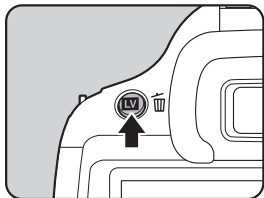

2 Position the subject inside the AF frame on the monitor, and press the shutter release button halfway.

The autofocus system operates.

The AF frame turns green when focused.

Subsequent steps are the same as shooting with the viewfinder.

Press the **LV/** button to end the Live View shooting.



AF frame



- You can magnify the central area in focus by pressing the **OK** button while the focus is locked (except when [Contrast AF] is set to [Tracking]). (p.109)
- In this manual, the explanations and examples are mainly for shooting with the viewfinder.

Use a flash to take pictures in low light or backlit conditions.

The built-in flash is optimum for a subject at a distance from approx. 0.7 m to 5 m. Vignetting (darkening of the corners of the image due to a lack of light) may occur when used at a distance closer than 0.7 m (this distance varies slightly depending on the lens being used and the sensitivity setting (p.244)).











- When using the built-in flash, remove the lens hood before shooting. Vignetting may occur depending on the lens being used and the shooting conditions. Refer to “Lens and Built-in Flash” (p.263) for details.
- The built-in flash always fully discharges when using a lens without an **A** (Auto) position.

























For details on the built-in flash and instructions on how to take pictures with an external flash, refer to “Using the Flash” (p.241).

Setting the Flash Mode









Flash Mode	Function
 Auto Flash Discharge	Automatically measures the ambient light and determines whether to use the flash.
 Auto Flash+ Red-eye Reduction	Discharges a pre-flash for red-eye reduction before the automatic flash.
 Flash On	Discharges the flash for each picture.
 Flash On+ Red-eye Reduction	Discharges a pre-flash for red-eye reduction before the main flash.
 Slow-speed Sync	Sets to a slow shutter speed depending on the brightness. When using this to shoot a portrait with the sunset in the background, both the person and the background are captured beautifully. (p.242)
 Slow-speed Sync+ Red-eye	Discharges a pre-flash for red-eye reduction before the main flash is discharged with Slow-speed Sync.
 Trailing Curtain Sync	Discharges the flash immediately before closing the shutter. Captures moving objects as if they are leaving a light trail behind them.
 Wireless Mode	You can synchronize an optional external flash without using a sync cord. (p.248)

The flash modes that can be selected differ depending on the capture mode.

Capture Mode	Selectable Flash Mode
AUTO/SCN	     
P/Sv/Av	         
Tv/TAv/M/B	     



The flash does not discharge in the following capture modes:

-  mode
-  (Sunset) or  (Blue Sky) of **AUTO** mode
-  (Sunset),  (Blue Sky),  (Night Scene),  (Night Scene HDR),  (Backlight Silhouette),  (Candlelight),  (Stage Lighting) or  (Museum) of **SCN** mode

1 Press the four-way controller (◀) in standby mode.

The Flash Mode setting screen appears.

2 Use the four-way controller (◀▶) to select a flash mode, and press the OK button.

The camera is ready to take a picture.

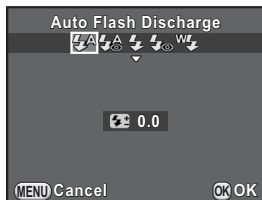

Slow-speed Sync and Trailing Curtain Sync slow down the shutter speed. To avoid camera shake, either turn on the Shake Reduction function, or use a tripod.

Compensating Flash Output

You can adjust the flash output in a range of -2.0 to +1.0. The following flash compensation values can be set according to the step interval set in [1. EV Steps] of the [C Custom Setting 1] menu.

EV Steps	Selectable Flash Compensation Value
1/3 EV	-2.0, -1.7, -1.3, -1.0, -0.7, -0.3, 0.0, +0.3, +0.7, +1.0
1/2 EV	-2.0, -1.5, -1.0, -0.5, 0.0, +0.5, +1.0

3

Basic Operations

1 Press the four-way controller (▼) in Step 2 on p.69.

2 Turn the rear e-dial (☀).

The flash compensation value is set.

Press the  button to reset the value to 0.0.



- When the flash output exceeds its maximum amount, the compensation will not be effective even if the compensation value is set to the plus (+) side.
- Compensating to the minus (-) side may have no effect if the subject is too close, the aperture is set to a large opening, or the set sensitivity is high.
- The flash output compensation is also effective for external flash units which support the P-TTL auto flash mode.

Using the Built-in Flash

1 Press the button.

The built-in flash pops up and begins charging. While the flash is charging,  blinks in the viewfinder or Live View screen.

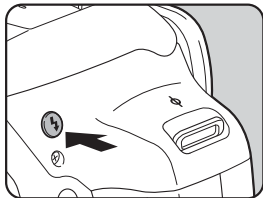

When the flash is fully charged,  stops blinking and stays lit continuously.

When you do not want the flash to discharge, keep the built-in flash retracted.



2 Take a picture.

The flash discharges.

When the flash mode is set to  or , the flash is not discharged if the lighting conditions do not require flash for correction even when the flash is popped up.

3 Push down on the top of the flash to retract the built-in flash.

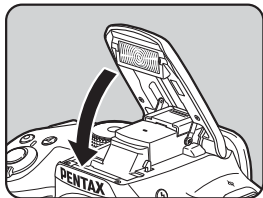

By default, you cannot take pictures while the built-in flash is being charged. If you want to take pictures while charging the built-in flash, set [16. Release While Charging] to [On] in the [C Custom Setting 3] menu.

Playing Back Images

You can play back captured images with the camera.

1 Press the button.

The camera switches to the single image display of playback mode and the most recently captured image (for movies, only the first frame) is displayed on the monitor.

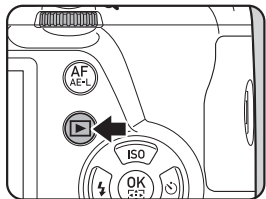

2 Review the captured image on the monitor.

Available operations

Four-way controller (◀)/ front e-dial (☀️) to the left	Displays the previous image.
Four-way controller (▶)/ front e-dial (☀️) to the right	Displays the next image.
 button	Saves the RAW image (only when the data is available).



- When the file format of the last captured image is JPEG, and its RAW data still remains in the buffer memory, you can save the RAW image during Instant Review or playback (if [Save RAW Data] is enabled in [Instant Review] of the [Rec. Mode 4] menu (p.214)).

If the image was captured using any of the following settings, the corresponding image listed below is saved.

- Exposure Bracketing RAW image of the third image
- Multi-exposure RAW image with Multi-exposure
- Interval Shooting RAW image for the last captured image
- HDR Capture RAW image with standard exposure
- Digital Filter RAW image without a filter effect

Images captured with  (Night Scene HDR) of SCN mode or Continuous Shooting cannot be saved in RAW format.

- Refer to "Playback Functions and Image Editing" (p.175) for details on the playback functions.

Deleting a Single Image

You can delete images one by one.



- Deleted images cannot be restored.
- Protected images cannot be deleted. (p.222)

1 Press the button, and display an image to delete.

2 Press the button.

The delete confirmation screen appears.

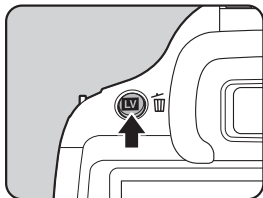

3 Press the four-way controller () to select [Delete], and press the OK button.

The image is deleted.

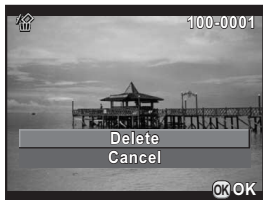

- You can delete multiple images at once. Refer to “Deleting Multiple Images” (p.186) for details.
- For the images captured with [File Format] (p.143) set to [RAW+], you can select the file format to delete in Step 3.

Memo

4 Shooting Functions

This chapter describes the various basic and advanced shooting functions available with this camera.

How to Operate the Shooting Functions	76
Selecting the Appropriate Capture Mode	82
Setting the Exposure	87
Focusing	101
Checking the Depth of Field (Preview)	114
Using the Shake Reduction Function to Prevent Camera Shake	116
Taking Pictures Continuously	123
Recording Movies	130

How to Operate the Shooting Functions

You can change capture-related settings using the direct keys, control panel, [📷 Rec. Mode] menu, [🎥 Movie] menu or [C Custom Setting] menu.



For details on how to use the direct keys and menus, refer to "How to Change Function Settings" (p.38).

Direct Keys Setting Items

4

Shooting Functions

Press the four-way controller (▲▼◀▶) in standby mode to set the following items.

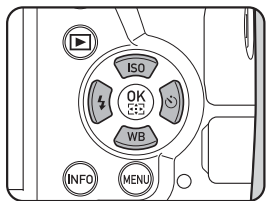

Key	Item	Function	Page
▲	Sensitivity	Sets the ISO sensitivity.	p.87
▼	White Balance	Adjusts the color balance to match the type of the light source illuminating the subject.	p.145
◀	Flash Mode	Sets the method of flash discharge.	p.68
▶	Drive Mode	Selects Single Frame, Continuous Shooting, Self-timer, Remote Control or Exposure Bracketing.	p.123 p.119 p.121 p.93



Rec. Mode Menu Items

The following items are available in the [📷 Rec. Mode 1-4] menus.

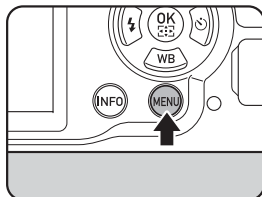
Press the **MENU** button in standby mode to display the [📷 Rec. Mode 1] menu.



Menu	Item	Function	Page	
📷1	Exposure Mode *1	Sets the capture mode when the mode dial is set to U1 or U2 .	p.173	
	Custom Image *2 *3	Sets the image finishing tone such as color and contrast before shooting an image.	p.157	
	Digital Filter *2	Applies a digital filter effect when taking pictures.	p.161	
	HDR Capture *2	Enables capturing images with high dynamic range.	p.151	
	Image Capture Settings	File Format *2	Sets the file format.	p.142
		JPEG Recorded Pixels *2	Sets the recording size of images saved in JPEG format.	
		JPEG Quality *2	Sets the quality of images saved in JPEG format.	
Color Space		Sets the color space to use.		
	AE Metering *2	Selects the part of the sensor to use for measuring brightness and determining exposure.	p.97	
📷2	AF Settings	AF.A *2	Sets the action for AFS/AF-C when shooting with the viewfinder.	p.103
		Expanded Area AF	Sets whether to continue to focus on your subject based on information from the focus points surrounding the selected focus point if your subject briefly moves out from the selected focus point when the focus point selection mode is set to [Select].	p.105
		AF Active Area *2	Selects the part of the viewfinder to focus on.	p.104
		AF Assist Light	Sets whether to use the AF assist light when autofocusing in dark locations.	p.103



Menu	Item	Function	Page
	Lens Correction *2	Reduces distortions and lateral chromatic aberrations occurring due to lens properties.	p.153
	Multi-exposure	Creates a picture by taking multiple exposures and merging them into a single image.	p.128
	Interval Shooting	Takes pictures at a set interval from a set time.	p.125
	D-Range Settings *2	Expands the dynamic range and prevents bright and dark areas from occurring.	p.150
	High-ISO NR	Sets the Noise Reduction setting when shooting with a high ISO sensitivity.	p.98
	Slow Shutter Speed NR	Sets the Noise Reduction setting when shooting with a slow shutter speed.	p.100
	Composition Adjust.	Allows you to adjust the composition of your image using the Shake Reduction mechanism.	p.155
	Electronic Level	Sets whether to display the electronic level which detects whether the camera is level.	p.212
	Horizon Correction	Corrects the tilt (right and left) of the image.	p.118
	Shake Reduction *2	Activates the Shake Reduction function.	p.116
	Input Focal Length	Sets the focal length when using a lens for which focal length information cannot be obtained.	p.264
	Live View	Sets the Live View display and focus method settings.	p.107
	Instant Review	Sets the Instant Review display settings.	p.214
	E-Dial Programming	For each exposure mode, you can set what the front and rear dials control.	p.164
	Button Customization	Sets the function of the RAW/Fx button and AF/AE-L button.	p.167
	Memory	Determines which settings to save when the power is turned off.	p.217
	GPS	Sets the functions for when the optional GPS unit is attached to the camera.	p.269
	Save USER Mode	Saves the current camera settings as USER mode so you can use them by setting the mode dial to U1 or U2 .	p.170

*1 Appears only when the mode dial is set to **U1** or **U2**.

*2 Can also be set through the control panel.

*3 When the mode dial is set to **SCN**, [Scene Mode] appears instead.

Movie Menu Items

The following items are available in the [ Movie 1] menu. Press the **MENU** button when the mode dial is set to  to display the [ Movie 1] menu.

Menu	Item	Function	Page	
 1	Exposure Setting *1	Selects the movie exposure mode from P , Av , or M mode.	p.130	
	Movie Capture Settings	Recorded Pixels *1		Sets the number of recorded pixels and size of the movie.
		Framerate *1		Sets the number of frames shot per second.
		Quality Level *1		Sets the quality level of the movie.
	Recording Sound Level *1	Sets the microphone sensitivity.		
	Movie SR *1	Activates the Movie Shake Reduction function.		
	Interval Movie	Takes still pictures at a set interval from a set time and saves it as a single movie file.	p.134	

*1 Can also be set through the control panel.

Custom Setting Menu Items

The following items of the [C Custom Setting 1-4] menus enable you to make the best use of the camera.

Menu	Item	Function	Page
C1	1. EV Steps	Sets the adjustment steps for exposure.	p.92
	2. Sensitivity Steps	Sets the adjustment steps for ISO sensitivity.	p.88
	3. Meter Operating Time	Sets the meter operating time.	p.97
	4. AE-L with AF Locked	Sets whether to lock the exposure value when the focus is locked.	p.96
	5. Link AE and AF Point	Sets whether to link the exposure and AF point in the focusing area when [AE Metering] is set to [Multi-segment].	p.97
	6. Bracketing Order	Sets the order for Exposure Bracketing shooting.	p.93
	7. One-Push Bracketing	Sets whether to shoot three frames with one release when using Exposure Bracketing.	p.95
C2	8. Bulb (B) Mode Options	Sets the operation when pressing the shutter release button in B mode.	p.91
	9. WB When Using Flash	Sets the white balance setting when using the flash.	p.147
	10. AWB in Tungsten Light	Sets whether to adjust the tungsten light color tone when the white balance is set to AWB (Auto White Balance).	—
	11. Color Temperature Steps	Sets the adjustment steps for color temperature.	p.149
	12. AF.S Setting	Sets the action priority for when the focus mode is set to AF.S and the shutter release button is fully pressed.	p.102
	13. AF.C Setting	Sets the action priority for Continuous Shooting when the focus mode is set to AF.C .	p.103
	14. AF with Remote Control	Sets whether to use autofocus when shooting with a remote control unit.	p.122

Menu	Item	Function	Page
C3	15. Superimpose AF Area	Sets whether to display the active AF point in red in the viewfinder.	p.104
	16. Release While Charging	Sets whether to release the shutter while charging the built-in flash.	p.71
	17. Flash in Wireless Mode	Sets the built-in flash discharge method in wireless mode.	p.249
	18. Save Rotation Info	Sets whether to save rotation information when shooting.	p.178
	19. Save Menu Location	Sets whether to save the last menu tab displayed on the monitor and to display it again the next time the MENU button is pressed.	p.215
	20. Catch-in Focus	Enables Catch-in Focus shooting when a manual focus lens is attached, and the shutter is released automatically when the subject comes into focus.	p.113
	21. AF Fine Adjustment	Allows you to precisely fine tune your lenses with the camera's autofocus system.	p.112
C4	22. Using Aperture Ring	Sets whether to enable shutter release when the lens aperture ring is set to a position other than A .	p.265
	Reset Custom Functions	Resets all the settings in the [C Custom Setting 1-4] menus to the defaults.	p.219

Selecting the Appropriate Capture Mode

This camera features various capture modes, enabling you to take pictures with settings suited for your photographic vision. In this manual, the capture modes are referred to as follows.

Capture Mode	Characteristics	Page
AUTO (Auto Picture) mode	Automatically selects the optimal capture mode for the subject.	p.83
SCN (Scene) mode	Lets you choose the capture mode from various scene styles.	p.84
Exposure modes (P/Sv/Tv/Av/TAv/M/B)	Changes the shutter speed and aperture value, and takes pictures.	p.86
 (Movie) mode	Records a movie.	p.132
USER modes (U1/U2)	Lets you capture images with the saved camera settings. Up to two settings can be saved.	p.170

- 1 Turn the mode dial to set the desired capture mode to the dial indicator.

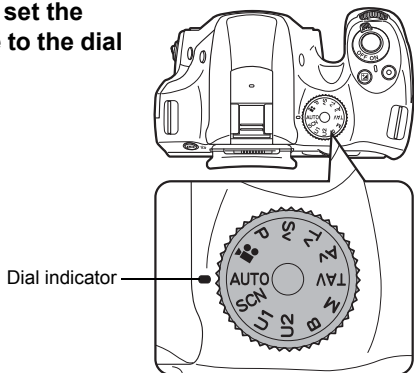



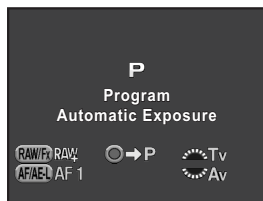





The selected capture mode is displayed for 3 seconds on the monitor (guide display).



You can set the camera to not display the guides in [LCD Display] of the [Set-up 1] menu. (p.212)

Auto Picture Modes

When set to **AUTO** (Auto Picture) mode, the camera automatically selects the optimal mode from the following capture modes for the subject.

















Mode	Characteristics
 Standard	This mode is selected when none of the following modes apply.
 Portrait	For capturing portraits. Reproduces a healthy and bright skin tone.
 Landscape	For capturing landscape views. Increases color saturation and produces a vivid color image.
 Macro	For capturing tiny objects at close focus range like flowers, coins, jewelry, and more.
 Moving Object	For capturing images of fast moving subjects, such as at sporting events.
 Night Scene Portrait	For capturing images of people in low light conditions, such as dusk or at night. Even though the flash is used, the camera will use slow shutter speeds so the background areas beyond the flash reach will also appear correctly exposed in the picture (Slow-speed Sync (p.242)). To prevent camera shake, either turn on the Shake Reduction function, or mount the camera on a tripod.
 Sunset	For capturing sunrises or sunsets in beautiful, vivid color.
 Blue Sky	For capturing images of blue sky. Produces a more impressive deep blue.
 Forest	Enhances colors of trees and sunbeams through foliage and produces a vivid color image.





The autofocus mode is fixed to **AFA** when shooting with the viewfinder. (p.103) If the camera determines that  is the optimal mode, the autofocus mode is fixed to **AFC**, while **AFS** is used for all other modes.









Scene Modes

When set to **SCN** (Scene) mode, you can choose from the following shooting scenes.

Mode	Characteristics
 Portrait	For capturing portraits. Reproduces a healthy and bright skin tone.
 Landscape	For capturing landscape views. Increases color saturation and produces a vivid color image.
 Macro	For capturing tiny objects at close focus range like flowers, coins, jewelry, and more.
 Moving Object	For capturing images of fast moving subjects, such as at sporting events. The drive mode is fixed to [Continuous Shooting (Hi)].
 Night Scene Portrait	For capturing images of people in low light conditions, such as dusk or at night. Even though the flash is used, the camera will use slow shutter speeds so the background areas beyond the flash reach will also appear correctly exposed in the picture (Slow-speed Sync (p.242)). To prevent camera shake, either turn on the Shake Reduction function, or mount the camera on a tripod.
 Sunset	For capturing sunrises or sunsets in beautiful, vivid color.
 Blue Sky	For capturing images of blue sky. Produces a more impressive deep blue.
 Forest	Enhances colors of trees and sunbeams through foliage and produces a vivid color image.
 Night Scene	Used for shooting at night. Use a tripod or flat surface to prevent camera shake blur.
 Night Scene HDR	Generates a single HDR image with less noise from 3 images (-3 EV, Standard, and +3 EV) captured in dim lighting. The file format is fixed to [JPEG].
 Night Snap	For taking snapshots in poorly lit place.
 Food	For capturing images of food. Saturation will be rather high to make it look appetizing.
 Pet	For capturing moving pets. The drive mode is fixed to [Continuous Shooting (Hi)].
 Kids	For capturing moving kids. Reproduces healthy and bright skin tone. The drive mode is fixed to [Continuous Shooting (Hi)].
 Surf & Snow	For capturing images of dazzling backgrounds, such as snowy mountains.
 Backlight Silhouette	Produces a silhouette image of subject in backlight condition.

Mode	Characteristics
 Candlelight	For capturing scenes in candlelight.
 Stage Lighting	For capturing moving subjects in poorly lit place.
 Museum	For capturing images in places where a flash is prohibited.



The flash is deactivated in , , , , , , , , and  modes. To prevent camera shake, either turn on the Shake Reduction function, or mount the camera on a tripod.



When shooting with the viewfinder, the autofocus mode is automatically set according to the selected shooting scene. (p.103)

Selecting a Scene Mode

1 Set the mode dial to SCN.

The camera switches to the SCN mode status screen.



2 Press the INFO button.

The icon for the currently selected capture mode appears in the control panel.

3 Use the four-way controller (▲▼◀▶) to select [Scene Mode], and press the OK button.

The Scene Mode selection screen appears.

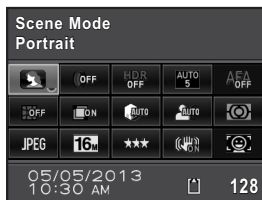

4 Use the four-way controller (▲▼◀▶) or rear e-dial (🔆) to choose a scene mode, and press the OK button.

The camera returns to the control panel and is ready to take a picture.

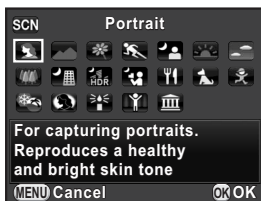

When the **MENU** button is pressed while the mode dial is set to **SCN**, the item [Scene Mode] appears on the [📷 Rec. Mode 1] menu. Press the four-way controller (▶) to display the Scene Mode selection screen and you can select a scene mode in the same way as described in Step 4.

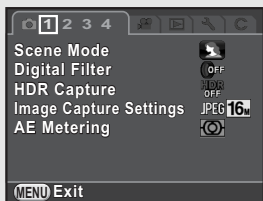

Exposure Modes

Use the following exposure modes to change the shutter speed and aperture value.

Mode	Characteristics	Page
P Program Automatic Exposure	Automatically sets the shutter speed and aperture value to obtain a proper exposure according to the program line.	p.89
Sv Sensitivity Priority Automatic Exposure	Lets you set the desired sensitivity to suit the brightness of the surroundings.	
Tv Shutter Priority Automatic Exposure	Lets you set the desired shutter speed for expressing subject movement.	
Av Aperture Priority Automatic Exposure	Lets you set the desired aperture value for controlling the depth of field.	
TAv Shutter & Aperture Priority Automatic Exposure	Automatically sets the sensitivity to obtain a proper exposure with the set shutter speed and aperture value.	
M Manual Exposure	Lets you set the sensitivity, shutter speed, and aperture value to match your photographic vision.	
B Bulb Exposure	Lets you capture images that require slow shutter speeds such as fireworks and night scenes.	p.91

Setting the Sensitivity

You can set the sensitivity to suit the brightness of the surroundings. The sensitivity can be set to [ISO AUTO] or within a sensitivity range equivalent to ISO 100 to 51200. The default setting is [ISO AUTO].

1 Press the four-way controller (▲) in standby mode.

The Sensitivity setting screen appears.

2 Use the four-way controller (▲▼) to select [ISO AUTO] or [ISO].

ISO AUTO	Sets the range to be adjusted automatically.
ISO	Sets a fixed value.

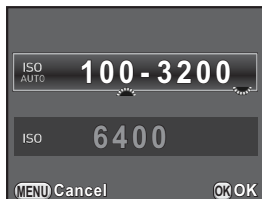

4

Shooting Functions

3 Turn the rear e-dial (☀️) to change the sensitivity value.

For [ISO AUTO], turn the front e-dial (☀️) to set the minimum sensitivity.

4 Press the OK button.

The camera is ready to take a picture.



- In **TAv** mode, or (Night Scene HDR)/ (Night Snap)/ (Stage Lighting) of **SCN** mode, the sensitivity is fixed to [ISO AUTO (up to ISO 6400 for **SCN** mode)].
- In **Sv** or **B** mode, [ISO AUTO] is not displayed. If the mode dial is set to **B**, the sensitivity is set to the last fixed value. If the mode dial is set to **M** when the sensitivity is set to [ISO AUTO], the camera operates in **TAv** mode.
- More noise may appear in captured images if a higher sensitivity is set. You can reduce image noise by using Noise Reduction. Set in [High-ISO NR] of the [Rec. Mode 3] menu. (p.98)
- You can select whether to set the sensitivity in increments of 1 EV or in accordance with the EV step setting for exposure (p.92). This can be set in [2. Sensitivity Steps] of the [**C** Custom Setting 1] menu.

Changing the Exposure Mode

This camera features the following exposure modes. The settings available for each exposure mode are as follows.

✓: Available #: Restricted ×: Not available

Exposure Mode	Change Shutter Speed	Change Aperture Value	Change Sensitivity	EV Compensation
P Program Automatic Exposure	#*1	#*1	✓	✓
Sv Sensitivity Priority Automatic Exposure	×	×	✓*2	✓
Tv Shutter Priority Automatic Exposure	✓	×	✓	✓
Av Aperture Priority Automatic Exposure	×	✓	✓	✓
TAv Shutter & Aperture Priority Automatic Exposure	✓	✓	✓	✓
M Manual Exposure	✓	✓	✓*3	✓
B Bulb Exposure	×	✓	✓*2	×

*1 In [E-Dial Programming] of the [Rec. Mode 4] menu, you can make the setting so that the shutter speed and/or aperture value can be changed by turning the front/rear e-dial. (p.164)

*2 [ISO AUTO] is not available.

*3 If the mode dial is set to **M** when the sensitivity is set to [ISO AUTO], the camera operates in **TAv** mode.

1 Set the mode dial to **P**, **Sv**, **Tv**, **Av**, **TAv**, **M** or **B**.

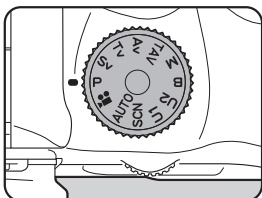

or appears on the status screen for the value that can be changed.



The value that can be changed is underlined in the viewfinder.

During Live View, ► appears for the value that can be changed.



2 Turn the rear e-dial (☀).

The aperture value can be changed in **Av**, **TAv**, **M**, or **B** mode.

The sensitivity can be changed in **Sv** mode.

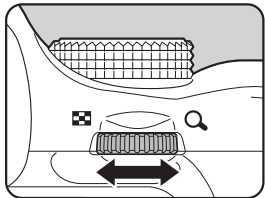

3 Turn the front e-dial (☀).

The shutter speed can be changed in **Tv**, **TAv**, or **M** mode.

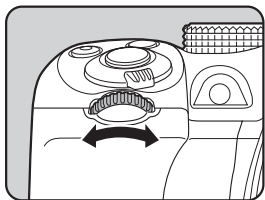

In **M** mode, the difference from the proper exposure is displayed in a bar scale while the shutter speed or aperture value is adjusted. The exposure value blinks red when the difference from the proper exposure is ± 3.0 or larger.



- The proper exposure may not be obtained with the selected shutter speed and aperture value when the sensitivity is set to a fixed value (p.87).
- For each exposure mode, you can set the functions for when the front/rear e-dial is turned or the \odot button is pressed. Set in [E-Dial Programming] of the [Camera Rec. Mode 4] menu. (p.164)

Bulb Shooting

This is useful when capturing images of night scenes and fireworks which require long exposures.

1 Set the mode dial to **B** (Bulb).

2 Press the shutter release button.

The shutter remains open as long as the shutter release button is kept pressed.

3 Take your finger off the shutter release button.

Exposure ends.



In **B** mode, the following functions are not available.

- Continuous Shooting
- Exposure Bracketing
- EV Compensation
- AE Lock
- Interval Shooting
- HDR Capture
- Shake Reduction



- You can set the operation of the shutter release button in **B** mode in [8. Bulb (B) Mode Options] of the [C Custom Setting 2] menu.

Mode1	Exposure continues while the shutter release button is pressed. (default setting)
Mode2	Exposure starts with the first press of the shutter release button and ends with the second press of the shutter release button.

- More noise may appear in captured images if a slower shutter speed is set. You can reduce image noise by using Noise Reduction. Set in [Slow Shutter Speed NR] of the [Rec. Mode 3] menu. (p.100)
- Use a tripod and the optional cable switch or an optional remote control unit to prevent camera shake during Bulb shooting.
- We recommend using the optional AC adapter kit as the battery drain is high during Bulb shooting.
- When the optional GPS unit is attached and [Action in B Mode] is set to [ASTROTRACER] in [GPS] of the [Rec. Mode 4] menu, the ASTROTRACER function is activated in **B** mode. (p.270)

Adjusting the Exposure

This allows you to deliberately overexpose (brighten) or underexpose (darken) your picture.

The compensation value can be set between -5 and +5 EV (-2 and +2 EV in  mode). The value that can be set varies according to the step interval set in [1. EV Steps] of the [C Custom Setting 1] menu.

EV Steps	Exposure Compensation Value
1/3 EV	$\pm 0.3, \pm 0.7, \pm 1.0, \pm 1.3, \pm 1.7, \pm 2.0, \pm 2.3, \pm 2.7, \pm 3.0, \pm 3.3, \pm 3.7, \pm 4.0, \pm 4.3, \pm 4.7, \pm 5.0$
1/2 EV	$\pm 0.5, \pm 1.0, \pm 1.5, \pm 2.0, \pm 2.5, \pm 3.0, \pm 3.5, \pm 4.0, \pm 4.5, \pm 5.0$

4

Shooting Functions

- 1 Press the  button (1), and then turn the rear e-dial (2).

The exposure is adjusted.

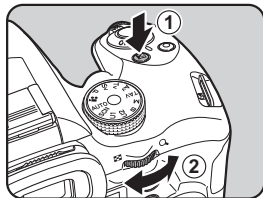

 and the compensation value are displayed in the status screen, viewfinder, and Live View screen during adjustment.





Available operations

	button	Starts/ends selecting the compensation value.
	button	Resets the compensation value to the default setting.



- EV Compensation is not available in **B** mode.
- The set compensation value is not canceled by turning the camera off or by switching to another capture mode.

Changing the Exposure Automatically when Shooting (Exposure Bracketing)

You can take three consecutive pictures at three different exposure levels.



Standard exposure



Underexposure



Overexposure

Set the bracketing order in [6. Bracketing Order] of the [**C** Custom Setting 1] menu.

0 - +	Standard → Underexposed → Overexposed (default setting)
- 0 +	Underexposed → Standard → Overexposed
+ 0 -	Overexposed → Standard → Underexposed
0 + -	Standard → Overexposed → Underexposed



Exposure Bracketing is not available in the following situations.

- when **B** mode, or (Moving Object)/ (Night Scene HDR)/ (Pet)/ (Kids) of **SCN** mode is set
- when Interval Shooting, Multi-exposure or HDR Capture is set

1 Press the four-way controller (▶) in standby mode.

The Drive Mode setting screen appears.

2 Use the four-way controller (◀▶) to select .

3 Press the four-way controller (▼), and set the bracket value.

The value that can be set varies according to the step interval set in [1. EV Steps] of the [C Custom Setting 1] menu. (p.92)

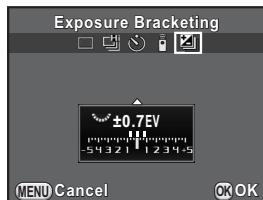

Available operations

Rear e-dial (to the right (Q))	Increases the bracket value.
Rear e-dial (to the left (Q))	Reduces the bracket value.
button → Rear e-dial ()	Adjusts the EV compensation value (when taking pictures in either under- or overexposed direction only).
⊙ button	Resets the compensation value to the default setting.

4 Press the OK button.

The camera is ready to take a series of pictures.

5 Press the shutter release button halfway.

The EV compensation value is displayed in the status screen, viewfinder, and Live View screen when the subject comes into focus.

6

Press the shutter release button fully.

Press and hold the shutter release button until three pictures are taken. The pictures will be taken according to the order set in [6. Bracketing Order] of the [C Custom Setting 1] menu.



- When the focus mode is set to **A.F.S.**, the focus position is locked in the first image and is used for subsequent images.
- When you take your finger off the shutter release button during Exposure Bracketing, the exposure setting will remain effective for twice the amount of the meter operating time (p.97) (default setting is about 20 seconds) and you can take a picture at the next compensation value. After about twice the amount of the meter operating time elapses, the camera returns to settings for taking the first image.
- When [7. One-Push Bracketing] of the [C Custom Setting 1] menu is set to [On], even if the shutter release button is not continuously pressed, three pictures are automatically taken with one press of the shutter release button.
- Select [Single Frame Shooting] in the Drive Mode setting screen to cancel Exposure Bracketing. The setting is canceled automatically when the camera is turned off if you clear the check box for [Drive Mode] in [Memory] of the [Camera Rec. Mode 4] menu. (p.217)
- You can combine Exposure Bracketing with the built-in flash or an external flash (P-TTL auto only) to continuously change only the flash output.
- If you use Exposure Bracketing frequently, you can assign it to the **RAW/Fx** button. (p.167)

Locking the Exposure Before Shooting (AE Lock)

AE Lock is a function that locks the exposure (brightness) prior to taking a picture. Use this when the subject is too small to obtain a proper exposure or is backlit.

1 Assign [AE Lock] to the AF/AE-L button.

Refer to "Setting the AF/AE-L Button Operation" (p.169) for details.

2 Set the exposure, and press the AF/AE-L button.

The camera locks the exposure at that instant.

★ is displayed in the status screen, viewfinder, and Live View screen while the AE Lock is engaged.

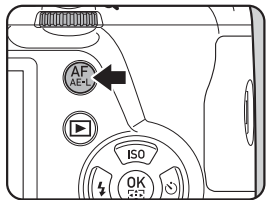

Press the **AF/AE-L** button again to cancel AE Lock.



- The exposure remains locked in the following situations.
 - while the **AF/AE-L** button is pressed
 - while the shutter release button is pressed halfway
 - for twice the amount of the meter operating time (p.97)
- You will hear a beep when AE Lock is activated and deactivated. The beep can be turned off. (p.208)
- AE Lock is not available in **B** mode.
- If you want to also lock the exposure when the focus is locked, set [4. AE-L with AF Locked] of the [**C** Custom Setting 1] menu to [On].
- When **M** mode is set, if the shutter speed or aperture value is changed while AE Lock is engaged, the combination of shutter speed and aperture value changes while the exposure remains the same.
- When using a zoom lens whose maximum aperture varies depending on the focal length, the combination of shutter speed and aperture value changes depending on the zooming position even while AE Lock is engaged.

Selecting the Metering Method

Choose the part of the sensor to use for measuring brightness and determining exposure.

 Multi-segment	The sensor meters the brightness in multiple zones. (default setting) Even in backlit locations, this mode automatically determines what level of brightness is in which portion and automatically adjusts exposure.
 Center-weighted	Metering is weighted at the center of the sensor. The sensitivity increases at the center and no automatic adjustment is performed even during backlit scenes.
 Spot	The brightness is measured only within a limited area at the center of the sensor. You can use this in combination with AE Lock (p.96) when a subject is too small to obtain a correct exposure.

1 Press the INFO button in standby mode.

The control panel appears.

2 Use the four-way controller (▲▼◀▶) to select [AE Metering], and press the OK button.

The [AE Metering] screen appears.

3 Use the four-way controller (◀▶) to select a metering method, and press the OK button.

The camera returns to the control panel.

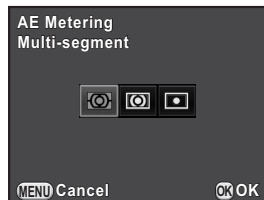

- You can also change the setting from the [Rec. Mode 1] menu.
- Exposure metering is performed immediately after the camera is turned on or when the capture mode is changed. Set the length of meter operating time in [3. Meter Operating Time] of the [Custom Setting 1] menu. Select from [10sec.] (default setting), [3sec.] or [30sec.].
- In [5. Link AE and AF Point] of the [Custom Setting 1] menu, you can link the exposure and AF point in the focusing area when  is selected.

Off	Exposure for multi-segment metering is determined regardless of the AF point. (default setting)
On	Exposure for multi-segment metering is adjusted according to the AF point.

Reducing the Image Noise (Noise Reduction)

When shooting with a digital camera, image noise (image roughness or unevenness) becomes noticeable in the following situations.

- when shooting with a high sensitivity setting
- when shooting with long exposures
- when the temperature of the CMOS sensor is high

You can reduce image noise by using Noise Reduction.



Pictures cannot be taken while the camera is performing a noise reduction process. In particular, if you use [Slow Shutter Speed NR], it may take more time to process.

4

High-ISO NR

Reduces noise at high ISO sensitivity settings.

- 1 Select [High-ISO NR] in the [📷 Rec. Mode 3] menu, and press the four-way controller (▶).

The [High-ISO NR] screen appears.

- 2 Press the four-way controller (▶), and use the four-way controller (▲ ▼) to select a setting.

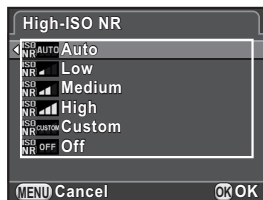

Auto	Applies Noise Reduction at optimally calculated levels throughout ISO range. (default setting)
Low/Medium/High	Applies Noise Reduction at constant chosen level throughout ISO range.
Custom	Applies Noise Reduction at user-defined levels for each ISO setting.
Off	Does not apply Noise Reduction at any ISO setting.

3 Press the OK button.

If you select [Auto], [Low], [Medium], [High] or [Off], proceed to Step 7.

4 Use the four-way controller (▲▼) to select [Setting], and press the four-way controller (▶).

The screen to set the noise reduction level according to the ISO sensitivity appears.

5 Use the four-way controller (▲▼) to select a sensitivity value, and use the four-way controller (◀▶) to set the level of noise reduction which is applied to the selected sensitivity value.

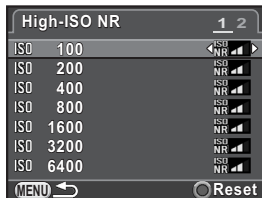

The sensitivity values displayed vary according to the [1. EV Steps] and [2. Sensitivity Steps] settings made in the [C Custom Setting 1] menu.

Available operations

Rear e-dial (🔍)	Switches between [High-ISO NR 1] and [High-ISO NR 2].
⊙ button	Resets the set value to the default setting.

6 Press the MENU button.

The screen that was displayed in Step 2 appears again.

7 Press the MENU button twice.

The camera is ready to take a picture.

Slow Shutter Speed NR

Reduces noise during long exposures.

- 1 Select [Slow Shutter Speed NR] in the [📷 Rec. Mode 3] menu, and press the four-way controller (▶).
- 2 Use the four-way controller (▲▼) to select a setting, and press the OK button.



Auto	Determines conditions such as shutter speed, sensitivity, and the camera's internal temperature, and automatically applies Noise Reduction as necessary. (default setting)
On	Applies Noise Reduction when the shutter speed exceeds 1 second.
Off	Does not apply Noise Reduction.

- 3 Press the MENU button.

The camera is ready to take a picture.

Setting the Focus Mode

Set the focus mode switch to **AF.S**, **C**, or **MF**.

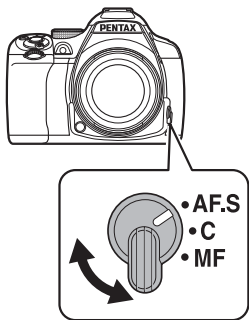

The autofocus methods for shooting with the viewfinder differ from those for shooting with Live View.

Shooting with the viewfinder	TTL phase-matching autofocus: Select from AF.S , AF.C , or AF.A mode which enables automatically switching between AF.S and AF.C . (p.102) Set the focusing point in [AF Active Area]. (p.104) Faster autofocus performance than “contrast detection AF” is possible.
Shooting with Live View	Contrast detection AF: Face detection and tracking are available. (p.106) The camera behaves the same whether the focus mode switch is set to AF.S or C .

Refer to “Adjusting the Focus Manually (Manual Focus)” (p.110) for details on **MF** mode.









If [Enable AF1] or [Enable AF2] is assigned to the **AF/AE-L** button, you can set the camera so that pressing the **AF/AE-L** button focuses automatically, in the same way as pressing the shutter release button halfway. By default, both pressing the shutter release button halfway and using the **AF/AE-L** button can perform autofocus. (p.169)

Autofocus Modes when Shooting with the Viewfinder

The following autofocus modes can be selected when shooting with the viewfinder.

A.F.S Single mode	<p>When the shutter release button is pressed halfway and the subject comes into focus, the focus is locked (focus lock) at that position. If the subject is outside the focusing area, focus the camera on the subject in the focusing area, lock the focus at that position (focus lock), and then recompose your picture.</p> <ul style="list-style-type: none"> The focus mode is fixed to A.F.S in (Portrait)/ (Landscape)/ (Macro)/ (Night Scene Portrait)/ (Forest)/ (Night Scene)/ (Night Scene HDR)/ (Food)/ (Sunset)/ (Surf & Snow)/ (Backlight Silhouette)/ (Candlelight)/ (Museum) of SCN mode. The AF assist light turns on as necessary. You can set the action priority for when the shutter release button is pressed fully in [12. AF.S Setting] of the [C Custom Setting 2] menu. 	
	Focus-priority	<p>The shutter cannot be released until the subject is in focus. (default setting)</p> <p>If the subject is too close to the camera, move back and take the picture. If the subject is difficult to focus, adjust the focus manually.</p>
	Release-priority	<p>The shutter can be released even if the subject is not in focus.</p>

<p>C (A.F.C) Continuous mode</p>	<p>The subject is kept in focus by continuous adjustment while the shutter release button is pressed halfway. The focus indicator  appears and you will hear a beep when the subject comes into focus. The shutter can be released even if the subject is not in focus.</p> <ul style="list-style-type: none"> • Available only when the mode dial is set to P, Sv, Tv, Av, TAv, M or B. • The focus mode is fixed to A.F.C in  (Moving Object)/ (Night Snap)/ (Pet)/ (Kids)/ (Stage Lighting) of SCN mode. • When the shutter release button is pressed halfway to focus, the camera tracks the subject if it is determined to be a moving object. • You can set the action priority for Continuous Shooting in [13. AF.C Setting] of the [C Custom Setting 2] menu. <table border="1" data-bbox="308 453 919 596"> <tr> <td data-bbox="308 453 425 533">Focus-priority</td> <td data-bbox="425 453 919 533">Takes pictures giving priority to keeping the subject in focus during Continuous Shooting. (default setting)</td> </tr> <tr> <td data-bbox="308 533 425 596">FPS-priority</td> <td data-bbox="425 533 919 596">Takes pictures giving priority to the shooting speed during Continuous Shooting.</td> </tr> </table>	Focus-priority	Takes pictures giving priority to keeping the subject in focus during Continuous Shooting. (default setting)	FPS-priority	Takes pictures giving priority to the shooting speed during Continuous Shooting.
Focus-priority	Takes pictures giving priority to keeping the subject in focus during Continuous Shooting. (default setting)				
FPS-priority	Takes pictures giving priority to the shooting speed during Continuous Shooting.				
<p>A.F.A Auto mode</p>	<p>Switches automatically between A.F.S and A.F.C modes according to the subject. Set in [A.F.A] of [AF Settings] in the [ Rec. Mode 2] menu.</p> <table border="1" data-bbox="296 701 912 817"> <tr> <td data-bbox="296 701 370 757"><input type="checkbox"/></td> <td data-bbox="370 701 912 757">Operates as specified by the camera's external focus mode switch. (default setting)</td> </tr> <tr> <td data-bbox="296 757 370 817"><input checked="" type="checkbox"/></td> <td data-bbox="370 757 912 817">Operates as A.F.A, overriding the external focus mode switch.</td> </tr> </table> <ul style="list-style-type: none"> • The focus mode is fixed to A.F.A in AUTO mode. • In SCN mode, A.F.A is not available because the focus mode is automatically set depending on the scene mode selected. • Even if A.F.A is selected, the focus mode is fixed to A.F.S during Live View shooting in P, Sv, Tv, Av, TAv, M or B mode. 	<input type="checkbox"/>	Operates as specified by the camera's external focus mode switch. (default setting)	<input checked="" type="checkbox"/>	Operates as A.F.A , overriding the external focus mode switch.
<input type="checkbox"/>	Operates as specified by the camera's external focus mode switch. (default setting)				
<input checked="" type="checkbox"/>	Operates as A.F.A , overriding the external focus mode switch.				







If you do not want to use the AF assist light in **A.F.S** mode, you can turn it off by clearing the check box for [AF Assist Light] in [AF Settings] of the [ Rec. Mode 2] menu.

Selecting the Focusing Point (AF Point)

Sets the focusing point when shooting with the viewfinder.

The selected focus point will light red in the viewfinder (Superimpose AF Area).

 Auto (5 AF Points)	Out of the 5 AF points, the camera selects the optimum AF point even if the subject is not centered. (default setting)
 Auto (11 AF Points)	Out of the 11 AF points, the camera selects the optimum AF point even if the subject is not centered.
 Select	Sets the focusing point to the user selected point from eleven points in the AF frame.
 Spot	Sets the focusing point to the center of the viewfinder.

1 Press the INFO button in standby mode.

The control panel appears.

2 Use the four-way controller (▲▼◀▶) to select [AF Active Area], and press the OK button.

The [AF Active Area] screen appears.

3 Use the four-way controller (◀▶) to select a focus point selection mode, and press the OK button.

The camera returns to the control panel.

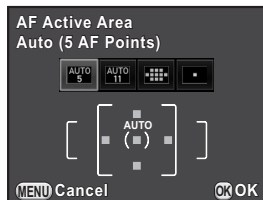

- You can also change the setting from [AF Active Area] in [AF Settings] of the [📷 Rec. Mode 2] menu.
- The selected focus point will not light red in the viewfinder when [Off] is selected for [15. Superimpose AF Area] in the [C Custom Setting 3] menu.
- The focus point selection mode is fixed to  regardless of this setting when using lenses other than DA, DA L, D FA, FA J, FA or F lenses.

Selecting the Desired Focusing Point

- 1 Select  in Step 3 on p.104, and press the **OK** button.
- 2 Press the **MENU** button or the shutter release button halfway.
The camera returns to the status screen and is ready to take a picture.
- 3 Select the desired **AF** point.



Available operations





Four-way controller (▲▼◀▶)	Changes the AF point.
OK button	Returns the AF point to the center.
Press and hold OK button	Disables changing the AF point and enables direct key operation of the four-way controller. To enable changing the AF point, press the OK button again while direct key operation is enabled.



- The position of the changed AF point is stored even if the focus point selection mode is switched to **AUTO**, **AF-ON** or **AF-LOCK**, or the camera is turned off.
- If [AF Active Area] is assigned to the **RAW/Fx** button in [Button Customization] of the [Rec. Mode 4] menu (p.167), press the **RAW/Fx** button to enable or disable changing the AF point, and turn the front/rear e-dial to change the AF point as in Step 4. You can select the upper or lower AF point with the front e-dial (▲/▼), and the left or right with the rear e-dial (◀/▶). Press the **OK** button to return the AF point to the center of the AF frame. This is useful when operating the camera while looking through the viewfinder.
- When [Expanded Area AF] in [AF Settings] of the [Rec. Mode 2] menu is enabled, if your subject briefly moves out from the focus point that was selected when the focus mode was set to **AFC** (or when [AF.A] was enabled), the camera will continue to focus on your subject based on information from the focus points (back-up focus points) surrounding the selected focus point. The back-up focus points are displayed in pink on the status screen.
- You will hear a beep when switching between enabling or disabling changing the AF point. The beep can be turned off. (p.208)

Setting the Contrast AF during Live View

You can select from the following autofocus methods when shooting with Live View.

 Face Detection	Detects and tracks faces of people. (default setting) The main face detection frame for autofocus and auto exposure is displayed in yellow.
 Tracking	Tracks the subject in focus when the shutter release button is pressed halfway.
 Select	Focuses on a desired area. The sensor is divided into 100 areas (10 horizontal by 10 vertical), and you can select a wider or narrower focusing area by using 4, 16, or 36 of those 100 available areas. (p.108)
 Spot	Focuses on a limited area at the center.

1 Press the INFO button in standby mode.

The control panel appears.

2 Use the four-way controller (▲▼◀▶) to select [Contrast AF], and press the OK button.

The [Contrast AF] screen appears.

3 Use the four-way controller (◀▶) to select the desired mode and press the OK button.

The camera returns to the control panel.

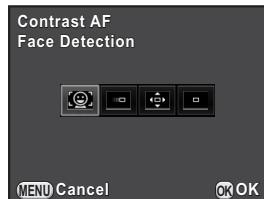



- You can also change the setting from [Contrast AF] in [Live View] of the [📷 Rec. Mode 4] menu.
- [Contrast AF] is fixed to in (Standard)/ (Portrait)/ (Night Scene Portrait) of **AUTO** mode or (Portrait)/ (Night Scene Portrait)/ (Kids) of **SCN** mode.
- To lock the focus and recompose the picture, select or .
- To take pictures when the subject is not in focus, set [12. AF.S Setting] to [Release-priority] in the [C Custom Setting 2] menu.
- You can set whether to display a grid, info overlay, histogram, and bright/dark area warning during Live View in [Live View] of the [📷 Rec. Mode 4] menu. When [Info Overlay] is disabled, the indicators which provide shooting information are not displayed. (Press the shutter release button halfway to display the shutter speed, aperture value, sensitivity and number of recordable still pictures.)

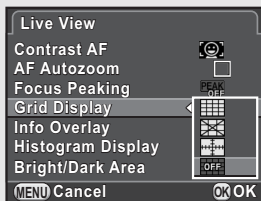

Selecting the Desired Focusing Area

You can set the range of the autofocusing area (AF area).

- 1 Select  in Step 3 on p.106, and press the **OK** button.

The camera returns to the control panel.

- 2 Press the **MENU** button or the shutter release button halfway.

The camera is ready to take a picture.

- 3 Press the  /  button.

The Live View image is displayed on the monitor.



- 4 Press the **OK** button.

The range of the selectable area is displayed with broken lines and a rectangle appears on it. You can set the AF area by changing the position and size of this rectangle.

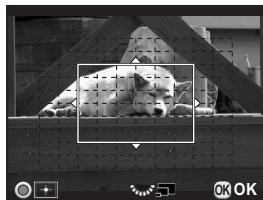
- 5 Select the AF area.



Available operations

Four-way controller (▲▼◀▶)	Changes the position of the AF area.
Rear e-dial ()	Changes the size of the AF area.
 button	Returns the AF area to the center.

- 6 Press the **OK** button.

The AF area is set.



The set AF area is saved in the memory even if the Contrast AF setting is changed or the camera is turned off.

Checking the Focus

When shooting with Live View, you can check the focus lock position by magnifying the image on the monitor, centering around the area in focus.

1 View the subject on the monitor, and press the shutter release button halfway.

The autofocus system operates.

2 Press the OK button while keeping the shutter release button pressed halfway.

While the shutter release button is pressed halfway, the image on the monitor is magnified centering around the AF point.

3 Turn the rear e-dial (☀️) to change the magnification.

Magnification can be selected from x2, x4 or x6.



4 Press the OK button or stop pressing the shutter release button halfway.

The camera is ready to take a picture.



- When [AF Autozoom] is enabled in [Live View] of the [📷 Rec. Mode 4] menu, the camera automatically magnifies the image 1 second after the focus is locked.
- In **MF** mode, the image can be magnified by simply pressing the **OK** button. (p.111)



The image cannot be magnified when [Contrast AF] is set to [Tracking].

Adjusting the Focus Manually (Manual Focus)

While looking through the viewfinder or viewing the Live View screen, turn the focusing ring until the subject is clearly visible. In **MF** mode, the shutter can be released by pressing the shutter release button fully even if the subject is not in focus.

Focusing Using the Viewfinder

You can manually adjust the focus using the matte field in viewfinder.

4

Shooting Functions

- 1 Set the focus mode switch to **MF**.**
- 2 Look through the viewfinder and turn the focusing ring.**

If the focusing ring is turned while pressing the shutter release button halfway, the focus indicator  appears and you will hear a beep when the subject comes into focus.

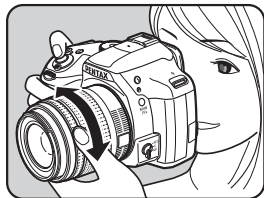

Focusing Using Live View

- 1 Set the focus mode switch to **MF**.
- 2 While viewing the monitor, turn the focusing ring.

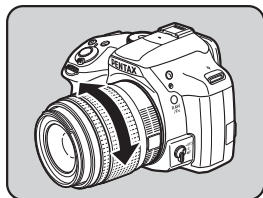

- 3 When it is difficult to check the focus, press the **OK** button.

The image on the monitor is magnified.



Available operations

Rear e-dial (☀️) to the right (Q)	Magnifies the image (up to 6 times)
Rear e-dial (☀️) to the left (⊞)	Reduces the image (up to 2 times)
Four-way controller (▲▼◀▶)	Changes the display area.
⊙ button	Changes the display area to the center.

- 4 Press the **OK** button or the shutter release button halfway.

The camera is ready to take a picture.



When [Focus Peaking] is enabled in [Live View] of the [📷 Rec. Mode 4] menu, the outline of the subject in focus is emphasized and makes it easier to check the focus. If you switch to **AF** mode after enabling Focus Peaking in **MF** mode, Focus Peaking also works in **AF** mode.

AF Fine Adjustment

You can precisely fine tune your lenses with the camera's autofocus system.



- **Be sure to use [AF Fine Adjustment] only when necessary. Care should be taken as adjusting the autofocus may make it difficult to capture images with the appropriate focus.**
- Any camera shake during test shooting may make it difficult to obtain the accurate focusing position. Therefore, always use a tripod when taking test shots.

1 Select [21. AF Fine Adjustment] in the [C Custom Setting 3] menu, and press the four-way controller (▶).

2 Use the four-way controller (▲ ▼) to select [On], and press the four-way controller (▶).

The [21. AF Fine Adjustment] screen appears.

3 Use the four-way controller (▲ ▼) to select [Apply All] or [Apply One].

Apply All	Applies the same adjustment value to all lenses.
Apply One	This item will appear only when the lens ID is obtained. Saves and applies a different adjustment value for each lens type. (Up to 20 lens types)
Reset	Resets the saved adjustment value to the default setting.

4 Press the four-way controller (▶), and adjust the value.



Available operations

Four-way controller (▶)/ Rear e-dial (☀) to the right (Q)	Adjusts the focus to a closer position.
Four-way controller (◀)/ Rear e-dial (☀) to the left (Z)	Adjusts the focus to a farther position.
⊙ button	Resets the adjustment value to the default setting.

5 Press the OK button.

The adjustment value is saved.

6 Press the MENU button three times.

The camera is ready to take a picture.

7 Take a test picture.

You can easily check focus accuracy by magnifying the image during Live View (p.109) or Digital Preview (p.115).

Shooting in Catch-in Focus Mode

When [20. Catch-in Focus] of the [C Custom Setting 3] menu is set to [On] and one of the following types of lenses is attached, Catch-in Focus shooting is enabled and the shutter is released automatically when the subject comes into focus.



- Manual focus lens
- DA or FA lens that has both **AF** and **MF** settings on the lens (the setting must be set to **MF** before shooting)

● How to Take Pictures

- 1 Set the focus mode switch to **A.F.S.**
Disable **A.F.A** (Autofocus/Auto) by clearing the check box for [A.F.A].
- 2 Set the focus on a position the subject will pass.
- 3 Press the shutter release button fully.
The shutter is released automatically when the subject comes into focus at the set position.

You can use the preview function to check depth of field, composition, exposure and focus before taking a picture.

There are two preview methods.

Preview Method	Description
 Optical Preview	For checking the depth of field with the viewfinder.
 Digital Preview	For checking the composition, exposure and focus on the monitor.



Optical Preview is always used for Interval Shooting and Multi-exposure.

4

Displaying the Optical Preview

1 Assign [Optical Preview] to the RAW/Fx button.

Refer to "Setting the RAW/Fx Button Operation" (p.167) for details.

2 Look through the viewfinder to focus on the subject.

3 Press the RAW/Fx button while looking through the viewfinder.

You can check the depth of field in the viewfinder while the RAW/Fx button is pressed.

During this operation, no shooting information is displayed in the viewfinder, and the shutter cannot be released.

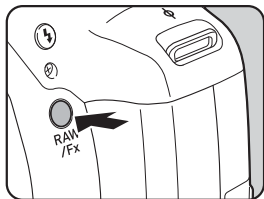

4 Take your finger off the RAW/Fx button.

Optical Preview is ended and the camera is ready to take a picture.

Displaying the Digital Preview

1 Assign [Digital Preview] to the RAW/Fx button.



Refer to "Setting the RAW/Fx Button Operation" (p.167) for details.

2 Focus on the subject, and press the RAW/Fx button.

 appears on the monitor during preview and you can check the composition, exposure and focus.



Available operations

Rear e-dial ()	Magnifies the preview image. (p.179)
 button	Saves the preview image.

3 Press the shutter release button halfway.

Digital Preview is ended and the autofocus system operates.



The maximum display time for Digital Preview is 60 seconds.

Using the Shake Reduction Function to Prevent Camera Shake

Taking Pictures Using the Shake Reduction Function

The Shake Reduction function reduces camera shake that occurs when the shutter release button is pressed.

The Shake Reduction function works effectively when taking pictures in the following situations.

- when taking pictures in dimly lit locations, such as indoors, at night, on cloudy days and in the shade
- when taking telephoto pictures



- The Shake Reduction function does not work for blurring caused by subject movement. To take pictures of a moving subject, increase the shutter speed.
- The Shake Reduction function may not fully reduce camera shake when taking close-up shots. In this case, it is recommended to deactivate the Shake Reduction function and use the camera with a tripod.
- The Shake Reduction function will not fully work when shooting with a very slow shutter speed, for example when panning or capturing images of night scenes. In this case, it is recommended to deactivate the Shake Reduction function and use the camera with a tripod.
- The Shake Reduction function is available with any PENTAX lens compatible with this camera. However, be sure to set the focal length before using a lens for which focal length information cannot be automatically obtained. Refer to "Functions Available with Various Lens Combinations" (p.261) for details.

Reducing Vertical and Horizontal Camera Shake

1 Press the INFO button in standby mode.

The control panel appears.



2 Use the four-way controller (▲▼◀▶) to select [Shake Reduction], and press the OK button.

The [Shake Reduction] screen appears.

3 Use the four-way controller (◀▶) to select or , and press the OK button.

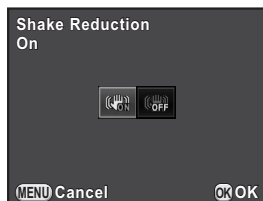
The camera returns to the control panel.





	Uses Shake Reduction. (default setting)
	Does not use Shake Reduction.

4 Press the shutter release button halfway.

The Shake Reduction function is activated, and  appears in the status screen, viewfinder, and Live View screen.



- The Shake Reduction function is not available in the following situations.
 - Self-timer shooting
 - Remote Control shooting
 - when **B** mode is set
 - when HDR Capture is set, and the Auto Align function is disabled
 - during Composition Adjustment
- The Shake Reduction function is activated in  (Night Scene HDR) of **SCN** mode (except when shooting with the self-timer).
- The Shake Reduction function will not fully work (for about 2 seconds) immediately after the camera is turned on or is restored from Auto Power Off. Wait for the Shake Reduction function to become stable before shooting.
- You can also change the setting from the  menu.

Correcting the Tilt of the Images

When an image is tilted, it can be corrected up to a maximum of ± 1.0 degrees (when Shake Reduction is turned on).

- 1 Select [Horizon Correction] in the [CAMERA] [Rec. Mode 3] menu.
- 2 Use the four-way controller (◀▶) to select (Off) or (On).

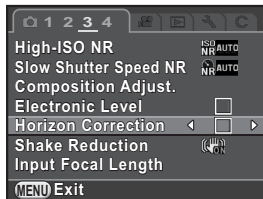



- 3 Press the MENU button.



The screen that was displayed before selecting the menu item appears again.

- 4 Aim the camera at the subject, and press the shutter release button halfway.



When [Horizon Correction] is set to On by selecting the check box, the following indicators appear on the status screen or Live View screen.



	Shake Reduction On + Horizon Correction On
	Shake Reduction Off + Horizon Correction On

Shooting with the Self-timer

 Self-timer (12 sec.)	The shutter is released after about 12 seconds. Use this mode to include the photographer in the picture.
 Self-timer (2 sec.)	The shutter is released about 2 seconds after the shutter release button is pressed. Use this mode to avoid camera shake when the shutter release button is pressed.



Shooting with the self-timer is not available in  (Moving Object)/ (Pet)/ (Kids) of SCN mode.

- 1** Mount the camera onto a tripod.
- 2** Press the four-way controller (▶) in standby mode.
The Drive Mode setting screen appears.
- 3** Use the four-way controller (◀▶) to select .
- 4** Press the four-way controller (▼), use the four-way controller (◀▶) to select  or , and press the OK button.

The camera is ready to take a picture.



- 5** Press the shutter release button halfway.

The autofocus system operates.

6 Press the shutter release button fully.

For , the self-timer lamp starts blinking slowly and then blinks rapidly 2 seconds before the shutter is released. A beep is heard and the rate increases. The shutter will be released about 12 seconds after the shutter release button is pressed fully.

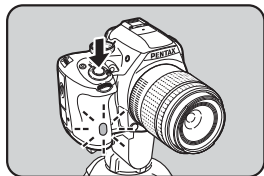

For , the shutter will be released about 2 seconds after the shutter release button is pressed fully.



- Select [Single Frame Shooting] in the Drive Mode setting screen to cancel shooting with the self-timer. The setting is canceled automatically when the camera is turned off if you clear the check box for [Drive Mode] in [Memory] of the [📷 Rec. Mode 4] menu. (p.217)
- The Shake Reduction function is not available.
- You can set the camera so that the beep does not sound. (p.208)
- The exposure may be affected if light enters the viewfinder (except in **M** mode). Use the AE Lock function (p.96) or attach the optional ME viewfinder cap.

Shooting with a Remote Control Unit (Optional)

The shutter can be released from a distance by using an optional remote control unit.

 Remote Control	The shutter is released immediately after the shutter release button on the remote control unit is pressed.
 Remote Control (3 sec. delay)	The shutter is released about 3 seconds after the shutter release button on the remote control unit is pressed.



Shooting with a remote control unit is not available in the following situations.

- when  (Moving Object)/ (Pet)/ (Kids) of SCN mode is set
- when Interval Shooting is set



4

1 Mount the camera onto a tripod.

2 Press the four-way controller (▶) in standby mode.

The Drive Mode setting screen appears.

3 Use the four-way controller (◀▶) to select .

4 Press the four-way controller (▼), use the four-way controller (◀▶) to select  or , and press the OK button.

The remote control receiver on the front of the camera will blink and the camera is in a standby status.

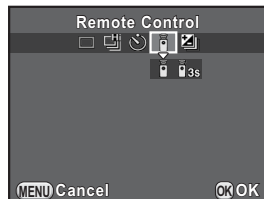

5 Press the shutter release button halfway.

The autofocus system operates.

6 Point the remote control unit towards the remote control receiver on the front of the camera, and press the shutter release button on the remote control unit.

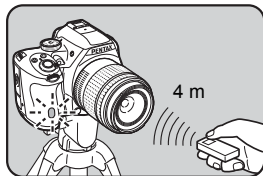

The maximum operating distance of a remote control unit is about 4 m from the front of the camera.



After a picture is taken, the remote control receiver lights for 2 seconds and then returns to blinking.





- By default, you cannot adjust the focus with a remote control unit. Focus on the subject first with the camera before operating with a remote control unit. When [14. AF with Remote Control] is set to [On] in the [C Custom Setting 2] menu, you can use a remote control unit to adjust the focus.
- Select [Single Frame Shooting] in the Drive Mode setting screen to cancel shooting with a remote control unit. The setting is canceled automatically when the camera is turned off if you clear the check box for [Drive Mode] in [Memory] of the [Rec. Mode 4] menu. (p.217)
- The Shake Reduction function is not available.
- When $\bar{\text{fl}}_{\text{ss}}$ is selected, the flash mode cannot be set to [Wireless Mode].
- The exposure may be affected if light enters the viewfinder (except in **M** mode). Use the AE Lock function (p.96) or attach the optional ME viewfinder cap.
- Shooting with a remote control unit may not be available in backlit conditions.
- When using the Remote Control Waterproof O-RC1, the autofocus system can be operated with the $\frac{1}{\infty}$ button. The **Fn** button cannot be used.
- The Remote Control F can send a remote control signal about 30,000 times. Contact a PENTAX Service Center to replace the battery (this will involve a fee).

Continuous Shooting

Pictures can be taken continuously while the shutter release button is fully pressed.

 Continuous Shooting (Hi)	Up to approximately 6 frames per second can be taken continuously (for JPEG images).
 Continuous Shooting (Lo)	Up to approximately 3 frames per second can be taken continuously (for JPEG images).



- Continuous Shooting is not available in the following situations.
 - when  (Night Scene HDR) of **SCN** mode, or **B** mode is set
 - when Interval Shooting or HDR Capture is set
- When  or  is set, you cannot save RAW images during Instant Review or playback.

4

1 Press the four-way controller (▶) in standby mode.

The Drive Mode setting screen appears.

2 Use the four-way controller (◀▶) to select .

3 Press the four-way controller (▼), use the four-way controller (◀▶) to select or , and press the OK button.

The camera is ready to take pictures continuously.

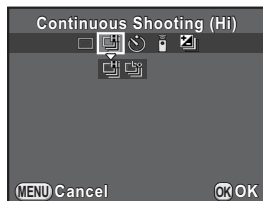

4 Press the shutter release button halfway.

The autofocus system operates.

5

Press the shutter release button fully.

Pictures are taken continuously while the shutter release button is fully pressed. Take your finger off the shutter release button to stop.



- The capture mode is fixed to in (Moving Object)/ (Pet)/ (Kids) of **SCN** mode.
- If the focus mode is set to **A.F.S**, the focus position is locked in the first frame and pictures are taken continuously at the same interval.
- If the focus mode is set to **A.F.C**, focusing is continuously activated during Continuous Shooting.
- The shutter cannot be released until charging is complete when using the built-in flash. Set [16. Release While Charging] to [On] in the [**C** Custom Setting 3] menu to enable shutter release before the built-in flash is ready.
- Select [Single Frame Shooting] in the Drive Mode setting screen to cancel Continuous Shooting. The setting is canceled automatically when the camera is turned off if you clear the check box for [Drive Mode] in [Memory] of the [Rec. Mode 4] menu. (p.217)

Interval Shooting

Takes pictures at a set interval from a set time.
The following items can be set.

Interval	Set the time interval between shots from 3 seconds to 24 hours.
Number of Shots	Set from 2 to 999. The number of pictures that can be set varies depending on the shooting conditions such as the amount of available space on the SD Memory Card.
Start Interval	Select whether to take the first picture now or at a set time. Selecting [Now] starts shooting immediately. When [Set Time] is selected, set [Start Time].
Start Time	Set the time at which to start shooting.



Interval Shooting is not available in the following situations.

- when **B** mode or mode is set
- when Multi-exposure is set

4

- 1 Select [Interval Shooting] in the [📷 Rec. Mode 2] menu, and press the four-way controller (▶).

The [Interval Shooting] screen appears.

- 2 Use the four-way controller (▲▼) to select [Interval], and press the four-way controller (▶).

- 3 Use the four-way controller (◀▶) to select hours, minutes, or seconds, and use the four-way controller (▲▼) to set the time.

Press the **OK** button to complete the setting.

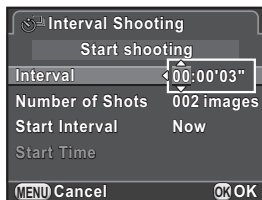

- 4 Use the four-way controller (▲▼) to select [Number of Shots], and press the four-way controller (▶).

- 5 Press the four-way controller (◀▶), and use the four-way controller (▲▼) to select the number of shots to be taken.

Press the **OK** button to complete the setting.

6 Use the four-way controller (▲▼) to select [Start Interval], and press the four-way controller (▶).

7 Use the four-way controller (▲▼) to select [Now] or [Set Time], and press the **OK** button.

If you selected [Now], proceed to Step 10.

8 Use the four-way controller (▲▼) to select [Start Time], and press the four-way controller (▶).

9 Use the four-way controller (◀▶) to select hours or minutes, and use the four-way controller (▲▼) to set the time.

Press the **OK** button to complete the setting.

10 Use the four-way controller (▲▼) to select [Start shooting], and press the **OK** button.

The camera is ready to take a series of interval pictures.

11 Press the shutter release button halfway.

The autofocus system operates.

12 Press the shutter release button fully.

When [Start Interval] is set to [Now], the first picture is taken. When set to [Set Time], shooting starts at the set time.

For shooting multiple pictures, pictures are taken at the interval set in Step 3.

To cancel shooting, press the **MENU** button.

After the set number of pictures are taken, [Interval Shooting complete] is displayed, and the camera returns to normal standby mode.



- Refer to “Interval Movie” (p.134) for information on how to perform Interval Shooting in mode.
- If the mode dial or the main switch is turned while shooting, the pictures that have been already taken are saved and Interval Shooting is ended.
- [Single Frame Shooting] is used regardless of the current drive mode setting.
- If the subject is not in focus with the focus mode set to **AF.S** or the previous image processing cannot be completed before taking the next picture, no picture may be taken.
- Although each shot taken is displayed with Instant Review, they cannot be magnified, deleted, or saved in RAW format.
- The monitor turns off during the intervals between shots.
- If the Auto Power Off function turns the camera off before starting Interval Shooting, the camera automatically turns on again when the shooting time approaches.



When using Interval Shooting, use the optional AC adapter kit or install a fully charged battery. If the battery becomes depleted during Interval Shooting, recording may stop.

Multi-exposure

You can create a picture by taking multiple exposures and merging them into a single image.



Multi-exposure is not available in the following situations.

- when (Night Scene HDR) of SCN mode, or mode is set
- when Interval Shooting, Digital Filter or HDR Capture is set

- 1** Select [Multi-exposure] in the [Rec. Mode 2] menu, and press the four-way controller (▶).

The [Multi-exposure] screen appears.

- 2** Use the four-way controller (▲▼) to select [Number of Shots], and press the four-way controller (▶).

- 3** Use the four-way controller (▲▼) to select the number of shots, and press the OK button.

Select from 2 to 9 shots.

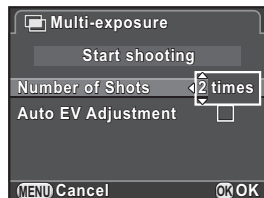

- 4** Use the four-way controller (▲▼) to select [Auto EV Adjustment], and use the four-way controller (◀▶) to select or .

When set to , the exposure is adjusted according to the number of shots.

- 5** Use the four-way controller (▲▼) to select [Start shooting], and press the OK button.

The camera is ready to take a series of pictures.

6 Take the picture.

The composite picture is displayed in Instant Review each time the shutter release button is pressed.

The following operations can be performed during Instant Review.

Available operations

LV /  button	Discards pictures taken up to that point and takes pictures again from the first frame.
--	---

MENU button	Saves pictures taken up to that point and cancels shooting.
--------------------	---

When the above operations are performed or after the set number of shots are taken, the screen in Step 3 appears again.

7 Press the MENU button twice.

Multi-exposure is ended.



Exposure Bracketing and Lens Correction are not available.

This camera enables you to record movies with the following format.

- Sound Monaural
- File format MPEG-4 AVC/H.264 (File extension: .MOV)

Changing the Settings for Movie Recording

Settings for recording movies can be changed using the [Movie] menu or the control panel.

Below, how to change the settings from the [Movie 1] menu is explained as an example.

4

1 Set the mode dial to **M**, and press the MENU button.

The [Movie 1] menu appears.

Turn the front e-dial (☀️) if you pressed the **MENU** button in any other capture mode.

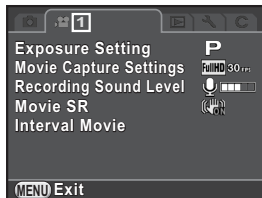

2 Use the four-way controller (▲▼) to select [Exposure Setting], and press the four-way controller (▶).

3 Use the four-way controller (▲▼) to select **P**, **Av** or **M**, and press the OK button.

P	Sets the exposure automatically. Allows you to adjust the EV compensation value. (default setting)
Av	Allows you to set the aperture and EV compensation values.
M	Allows you to set the shutter speed, aperture value, and sensitivity.

4 Use the four-way controller (▲▼) to select [Movie Capture Settings], and press the four-way controller (▶).

The [Movie Capture Settings] screen appears.

5 Select [Recorded Pixels].

Recorded Pixels	Display Resolution	Aspect Ratio	Frame Rate (fps)
FullHD (default setting)	1920×1080	16:9	30/25/24
HD	1280×720	16:9	60/50/30/25/24
VGA	640×480	4:3	30/25/24

When the setting is changed, the amount of recordable time for that setting appears at the top right of the screen.

6 Select [Framerate].

The frame rates that can be selected vary depending on the recorded pixels.

7 Set [Quality Level] to [★★★], [★★], or [★].

8 Press the MENU button.

The Movie 1] menu appears.

9 Use the four-way controller (▲▼) to select [Recording Sound Level], and use the four-way controller (◀▶) to select the recording sound level.

Set in the range from 0 to 5.

Sound is not recorded when (0) is selected.

10 Use the four-way controller (▲▼) to select [Movie SR], and press the four-way controller (▶).

11 Use the four-way controller (▲▼) to select or , and press the OK button.

	Uses Movie Shake Reduction. (default setting)
	Does not use Movie Shake Reduction.

12 Press the MENU button.

The camera is ready to record a movie.



The settings described in this section can also be set through the control panel.

Recording Movies

1 Set the mode dial to .

Live View for movie recording is displayed.

2 View the subject on the monitor.





Change the exposure setting as necessary.

Recording Sound Level Movie SR



Recordable Time

Available operations

Rear e-dial ()	Exposure Setting Av/M : Adjusts the aperture value (only before shooting).
Front e-dial ()	Exposure Setting M : Adjusts the shutter speed.
 button → Rear e-dial ()	Exposure Setting P/Av : Adjusts the EV compensation value (± 2 EV).
Four-way controller ()	Exposure Setting M : Adjusts the sensitivity setting.

3 Press the shutter release button halfway.

The autofocus system operates.

When the focus mode switch is set to **MF**, turn the focusing ring until the subject is clearly visible on the focusing screen.

4 Press the shutter release button fully.

Movie recording starts.

A red  displayed at the top right of the screen blinks during movie recording.

5 Press the shutter release button again.

Movie recording stops.



- When [Recording Sound Level] is set to a value other than (0), the camera operation sounds are also recorded. When recording a movie, mount the camera onto a tripod and do not operate the camera while recording.
- The flash is not available.
- When recording a movie using an image processing function such as Digital Filter, some frames may be omitted from the recorded movie.
- If the internal temperature of the camera becomes high during movie recording, the camera may be turned off automatically to protect the camera circuitry.



- When recording a movie, regardless of the focus mode setting, recording starts when the shutter release button is pressed fully even if the subject is not in focus.
- You can record a movie continuously up to 4 GB or 25 minutes. When the SD Memory Card is full, recording stops and the movie is saved.
- The screen display in mode is set according to the [Live View] setting made in the [Rec. Mode 4] menu. (p.107)
- You can set the functions for when the front/rear e-dial is turned or the button is pressed in [E-Dial Programming] of the [Rec. Mode 4] menu. (p.164)
- If you intend to shoot continuously for a long period, use of the optional AC adapter kit is recommended.
- You can also use an optional remote control unit to record a movie. (p.121) Press the four-way controller () in mode to display the screen for setting whether to use the remote control instead of the normal Drive Mode setting screen.

Interval Movie

Takes still pictures at a set interval from a set time and saves them as a single movie file (Motion JPEG, file extension: .AVI).

The following items can be set.

Interval	Select from 3 sec., 5 sec., 10 sec., 30 sec., 1 min., 5 min., 10 min., 30 min., or 1 hour.
Recording Time	Set the duration of recording from 12 seconds to 99 hours. The time that can be set varies depending on the [Interval] setting.
Start Interval	Select whether to take the first picture now or at a set time. Selecting [Now] starts shooting immediately. When [Set Time] is selected, set [Start Time].
Start Time	Set the time at which to start shooting.



Interval Movie is available only when the mode dial is set to .

- 1 Select [Interval Movie] in the [Movie 1] menu, and press the four-way controller (▶).

The [Interval Movie] screen appears.

- 2 Use the four-way controller (▲▼) to select [Interval], and press the four-way controller (▶).

- 3 Use the four-way controller (▲▼) to select the shooting interval, and press the OK button.

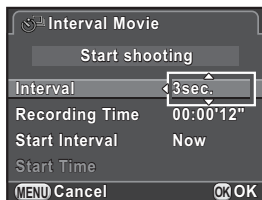

- 4 Use the four-way controller (▲▼) to select [Recording Time], and press the four-way controller (▶).

-
- 5** Use the four-way controller (◀▶) to select hours, minutes, or seconds, and use the four-way controller (▲▼) to set the time.

Press the **OK** button to complete the setting.

-
- 6** Use the four-way controller (▲▼) to select [Start Interval], and press the four-way controller (▶).

-
- 7** Use the four-way controller (▲▼) to select [Now] or [Set Time], and press the **OK** button.

If you selected [Now], proceed to Step 10.

-
- 8** Use the four-way controller (▲▼) to select [Start Time], and press the four-way controller (▶).

-
- 9** Use the four-way controller (◀▶) to select hours or minutes, and use the four-way controller (▲▼) to set the time.

Press the **OK** button to complete the setting.

-
- 10** Use the four-way controller (▲▼) to select [Start shooting], and press the **OK** button.

The camera is ready to record a movie.

-
- 11** Press the shutter release button halfway.

The autofocus system operates.

-
- 12** Press the shutter release button fully.

When [Start Interval] is set to [Now], a picture is taken immediately, Instant Review is displayed, and then the monitor turns off.

After the set number of pictures are taken, [Interval Shooting complete] is displayed, and the camera returns to normal standby mode.



When recording with Interval Movie, use the optional AC adapter kit or install a fully charged battery. If the battery becomes depleted during Interval Movie recording, recording may stop.

Playing Back Movies

Recorded movies can be played back in playback mode in the same manner as saved still pictures.

1 Select the movie to play back in the single image display of playback mode.

The first frame of the movie is displayed on the monitor.

2 Press the four-way controller (▲).

Movie playback starts.



Available operations

Four-way controller (▲)	Pauses/resumes playback.
Four-way controller (▶)	Forwards a frame (when paused).
Press and hold four-way controller (▶)	Fast-forwards playback.
Four-way controller (◀)	Reverses a frame (when paused).
Press and hold four-way controller (◀)	Fast-reverses playback.
Four-way controller (▼)	Stops playback. Displays the playback mode palette (when stopped). (p.176)
Rear e-dial (🔊)	Adjusts the volume (6 levels).
INFO button	Switches between [Standard Information Display] and [No Information Display].
📄 button	Saves the image on the monitor as a JPEG file (when paused). (p.137).

When the movie ends, playback stops and the first frame is displayed again.



- Use an optional AV cable to play back recorded movies on a TV screen or other AV devices. (p.202)
- QuickTime is required to play back movies transferred to a computer. (p.234)

Capturing a Still Picture from a Movie

You can capture a single frame from a movie and save it as a JPEG still picture.

1 Press the four-way controller (▲) in Step 2 on p.136 to pause the movie.

2 Use the four-way controller (◀▶) to display the frame to save as a still picture.

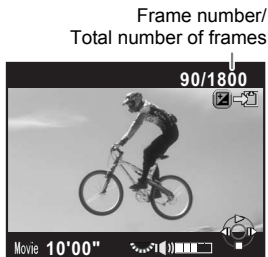

3 Press the  button.

The save confirmation screen appears.

4 Use the four-way controller (▲▼) to select [Save as], and press the OK button.

The captured image from the movie is saved in JPEG format.

Editing Movies

Movies can be divided and unwanted segments can be deleted.

- 1 Select the movie to play back in the single image display of playback mode.**

The first frame of the movie is displayed on the monitor.

- 2 Press the four-way controller (▼).**

The playback mode palette appears.

- 3 Use the four-way controller (▲▼◀▶) to select  (Movie Edit), and press the OK button.**

The movie editing screen appears.

- 4 Select a point where you want to divide the movie.**

The first frame at the dividing point is displayed at the top of the screen.

Up to four points can be selected to divide the original movie into five segments.

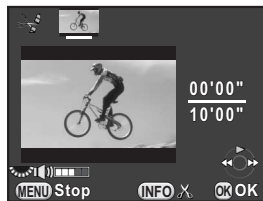

Available operations

Four-way controller (▲)	Plays back/pauses a movie.
Four-way controller (▶)	Forwards a frame (when paused).
Press and hold four-way controller (▶)	Fast-forwards playback.
Four-way controller (◀)	Reverses a frame (when paused).
Press and hold four-way controller (◀)	Fast-reverses playback.
Rear e-dial ()	Adjusts the volume (6 levels).
INFO button	Confirms/cancels a dividing point.

Proceed to Step 8 if you do not want to delete any segment.

- 5 Press the  button.**

The screen to select the segment(s) to delete is displayed.

6 Use the four-way controller (◀▶) to move the selection frame, and press the OK button.

The segment(s) to delete are specified. Multiple segments can be deleted at once.

Press the **OK** button again to cancel the selection.

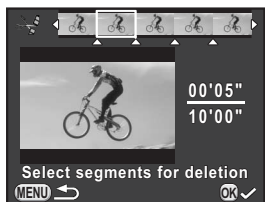

7 Press the MENU button.

The screen that was displayed in Step 4 appears again.

8 Press the OK button.

The save confirmation screen appears.

9 Use the four-way controller (▲▼) to select [Save as], and press the OK button.

The movie is divided at the specified points and the unwanted segments are deleted from it. The divided movie is then saved as separate files and the single image display reappears.



- Select dividing points in chronological order from the beginning of the movie. When canceling the selected dividing points, cancel each of them in reverse order (from the end of the movie to the beginning). In an order other than specified, you can neither select frames as a dividing point nor cancel the selections of the dividing points. You cannot, for example, select the frames prior to the last selected frame as a dividing point while selecting a dividing point.
- Movies with a short recording time cannot be divided.

Memo

5 Shooting Settings

This chapter describes image file formats and camera operating settings in capture mode.

Setting a File Format	142
Setting the White Balance	145
Correcting Images	150
Setting the Image Finishing Tone	157
Customizing the Button/E-dial Functions	164
Saving Frequently Used Settings	170

Setting a File Format

Set the file format, number of recorded pixels, quality level, and color space of still pictures.

- 1** Select [Image Capture Settings] in the [📷 Rec. Mode 1] menu, and press the four-way controller (▶).

The [Image Capture Settings] screen appears.

- 2** Use the four-way controller (▲▼) to select [File Format], [JPEG Recorded Pixels], [JPEG Quality] or [Color Space], and press the four-way controller (▶).

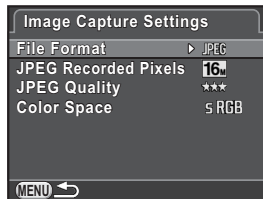

Refer to p.143 to p.144 for details about each of these settings.

- 3** Use the four-way controller (▲▼) to change the settings, and press the OK button.

- 4** Press the MENU button twice.

The screen that was displayed before selecting the menu item appears again.



- File Format, JPEG Recorded Pixels and JPEG Quality can also be set through the control panel.
- When File Format, JPEG Recorded Pixels or JPEG Quality is changed, the number of still pictures that can be recorded for that setting appears on the monitor.

File Format

You can set the format of image files.

JPEG	Captures images in JPEG format. (default setting) You can change the [JPEG Recorded Pixels] and [JPEG Quality] settings.
RAW	Captures images in CMOS sensor output format without processing. RAW files are recorded with the general-purpose DNG (Digital Negative) format designed by Adobe Systems. Effects of White Balance, Custom Image and Color Space are not applied to the captured images, but they are saved as actual original information. When you perform the development process by using the [RAW Development] function (p.198), you can create JPEG images with these effects.
RAW+	Captures images in both JPEG and RAW formats. When [One Push File Format] is assigned to the RAW/Fx button, you can press the button to temporarily change the file format and save an image in both file formats. (p.168)



- When Digital Filter or HDR Capture is set, the file format is fixed to [JPEG] and cannot be changed. To change the file format, deactivate these functions.
- In (Night Scene HDR) of **SCN** mode, images are saved in JPEG format, regardless of the [File Format] setting.

JPEG Recorded Pixels

Sets the recording size of images when the file format is set to [JPEG].

Recorded Pixels	Pixels
16M	4928×3264 (default setting)
12M	4224×2816
8M	3456×2304
5M	2688×1792



- The more pixels there are, the bigger the file size. The file size will also vary according to the [JPEG Quality] setting.
- The quality of a captured image depends on the shooting settings, resolution of the printer and a variety of other factors.

JPEG Quality

You can set the image quality level (compression ratio). The default setting is ★★★ (Best).

★★★ Best		Quality: clearer File size: larger
★★ Better		
★ Good		Quality: grainier File size: smaller

Color Space

You can select a color space to use.

sRGB	Mainly used for devices such as a computer. (default setting)
AdobeRGB	Covers a wider range of color than sRGB and is used for commercial uses such as industrial printing.









The file naming system changes depending on the color space setting as shown below. ("xxxx" is a four-digit sequential number.)

For sRGB: IMGpxxxx.JPG

For AdobeRGB: _IMGxxxx.JPG

Adjusts the color of an image based on ambient light conditions so that white objects appear white.

Item	Setting	Color Temperature *1
AWB Auto	Automatically adjusts the white balance. (default setting)	Approx. 4,000 to 8,000K
 Daylight	For use when taking pictures in sunlight.	Approx. 5,200K
 Shade	For use when taking pictures in the shade. It reduces the bluish color tones in a picture.	Approx. 8,000K
 Cloudy	For use when taking pictures on cloudy days.	Approx. 6,000K
 Fluorescent Light	For use when taking pictures under fluorescent lighting. Select the type of fluorescent light. D Fluorescent - Daylight Color N Fluorescent - Daylight White W Fluorescent - Cool White L Fluorescent - Warm White	Approx. 6,500K Approx. 5,000K Approx. 4,200K Approx. 3,000K
 Tungsten	For use when taking pictures under light bulbs or other tungsten light. It reduces the reddish color tones in a picture.	Approx. 2,850K
 WB Flash	For use when taking pictures using the built-in flash.	Approx. 5,400K
CTE *2	Use this to keep and strengthen the color tone of the light source in the image.	—
 Manual 1-3	Use this to manually adjust the white balance according to the lighting when taking pictures. Up to three settings can be saved.	—
K Color Temperature	Use this to set the color temperature value.	—

*1 The color temperatures (K) shown above are all estimates. These do not indicate precise colors.

*2 CTE = Color Temperature Enhancement



The white balance is fixed to **AWB** in **AUTO** and **SCN** modes.

1 Press the four-way controller (▼) in standby mode.

The White Balance setting screen appears.

The last image taken is displayed in the background.

2 Use the four-way controller (◀▶) to select the white balance.

When 𠄎 is selected, press the four-way controller (▼) and use the four-way controller (◀▶) to select **D**, **N**, **W**, or **L**.

Proceed to Step 6 if you do not need to change the parameters.



Available operations

RAW/Fx button	Uses Digital Preview to preview the background image with the white balance effect applied (only when shooting with the viewfinder).
𠄎 button	Saves the background image (only when the data is available).
INFO button	Displays the fine-tuning screen.

3 Press the INFO button.

The fine-tuning screen appears.

4 Fine-tune the white balance.

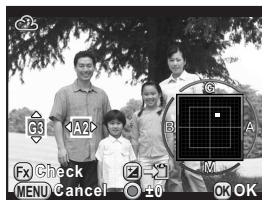

Available operations

Four-way controller (▲▼)	Adjusts the tone of the colors between green (G) and magenta (M).
Four-way controller (◀▶)	Adjusts the tone of the colors between blue (B) and amber (A).
⊙ button	Resets the adjustment value to the default setting.

5 Press the OK button.

The screen that was displayed in Step 2 appears again.

6 Press the OK button.

The camera is ready to take a picture.



To set the white balance for when the flash discharges, select [Auto White Balance], [Unchanged] or [Flash] in [9. WB When Using Flash] of the [C Custom Setting 2] menu.

Adjusting the White Balance Manually

You can adjust the white balance depending on the light source when taking pictures.

1 Select in Step 2 on p.146, and press the four-way controller (▼).

2 Use the four-way controller (◀▶) to select to .



3 Under the light you wish to measure the white balance of, select a white area as the subject.

Or, fully display a white sheet of paper in the center of the viewfinder or monitor.

4 Press the shutter release button fully.

Set the focus mode to **MF** when the shutter cannot be released.
The screen to select the measuring range is displayed.

-
- 5 Use the four-way controller (▲▼◀▶) to move the frame to the position you want to measure.**
-

- 6 Press the OK button.**

The white balance is measured, and the screen that was displayed in Step 2 appears again.

Adjust the white balance as necessary.

The message [The operation could not be completed correctly] appears when measuring is unsuccessful. Press the **OK** button to remeasure the white balance.

- 7 Press the OK button.**

The camera is ready to take a picture.



If a picture is extremely overexposed or underexposed, the white balance may not be adjusted. In this case, adjust exposure to the correct exposure before adjusting the white balance.

Saving the White Balance Settings of a Captured Image

You can copy the white balance settings of a captured image and save it as Manual White Balance.



Only the white balance settings of still pictures taken with this camera can be copied. However, the following images cannot be selected.

- Multi-exposure image
- Index image
- Still pictures captured from a movie

-
- 1 Press the four-way controller (▼) in the single image display of playback mode.**

The playback mode palette appears.

- 2 Use the four-way controller (▲▼◀▶) to select  (Save as Manual WB), and press the OK button.**

The save confirmation screen appears.

- 3 Turn the front e-dial () to select an image.**

- 4 Use the four-way controller (▲▼) to select a number, and press the OK button.**

The white balance settings of the selected image are saved as Manual White Balance and the camera is ready to take a picture. The white balance setting is .

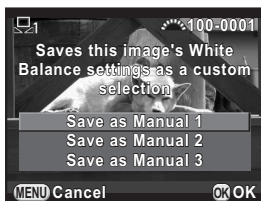

Adjusting the White Balance with Color Temperature

Use to set the color temperature value.

- 1 Select K in Step 2 on p.146, and press the INFO button.**
- 2 Adjust the color temperature with the front or rear e-dial.**

You can set the color temperature value within the range from 2500K to 10000K.

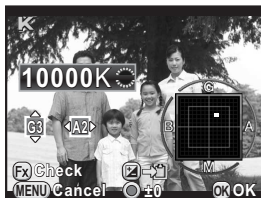

Color temperature steps vary depending on the e-dial.

E-dial	Kelvin	Mired *1
Front (☀️)	1 Step (100K)	1 Step (20M)
Rear (☀️)	10 Steps (1,000K)	5 Steps (100M)

*1 The default setting for Color Temperature step units is [Kelvin]. You can change the step units to [Mired] in [11. Color Temperature Steps] of the [C Custom Setting 2] menu. However, figures are converted to and displayed in Kelvin.

- 3 Press the OK button.**

The White Balance setting screen reappears.

- 4 Press the OK button.**

The camera is ready to take a picture.

The camera and lens properties can be automatically modified for when taking pictures.

Brightness Adjustment

Expands the dynamic range and enables a wider range of tones expression by the CMOS sensor and reduces the occurrence of overexposed and underexposed areas.

1 Press the INFO button in standby mode.

The control panel appears.

2 Use the four-way controller (▲▼◀▶) to select [Highlight Correction] or [Shadow Correction], and press the OK button.

The [Highlight Correction] or [Shadow Correction] screen appears.

3 Use the four-way controller (◀▶) to change the settings.

For Highlight Correction, select from [Auto] (default setting), [On] or [Off].

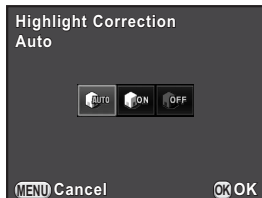

For Shadow Correction, select from [Auto] (default setting), [Low], [Medium], [High] or [Off].

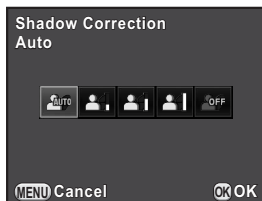

4 Press the OK button.

The camera returns to the control panel.



When the sensitivity is set to less than ISO 200 setting, [Highlight Correction] cannot be set to [On].



You can also set [Highlight Correction] and [Shadow Correction] in [D-Range Settings] of the [📷 Rec. Mode 2] menu.

High Dynamic Range Image Capture

High dynamic range photography is a way of expressing the entire range from dark to bright areas by capturing multiple images with different exposures (underexposed, properly exposed (standard), and overexposed), and combining them into a single image.

HDR Capture	Available by setting through the control panel or in the [📷 Rec. Mode 1] menu.
(Night Scene HDR)	Available by selecting from SCN mode. (p.84)

This section explains how to set [HDR Capture].



- HDR Capture is not available in the following situations.
 - when the file format is set to [RAW] or [RAW+]
 - when **B** mode is set
- During HDR Capture or in (Night Scene HDR) mode, the following functions are not available.
 - Continuous Shooting
 - Flash discharge
 - Digital Filter
 - Exposure Bracketing
 - Multi-exposure
- If (Night Scene HDR) is selected, settings for this mode override the settings for HDR Capture.
- During HDR Capture or in (Night Scene HDR) mode, multiple images are combined together to create a single image, so it will take time to save an image.

1

Select [HDR Capture] in the [📷 Rec. Mode 1] menu, and press the four-way controller (▶).

The [HDR Capture] screen appears.

- 2** Press the four-way controller (▶), use the four-way controller (▲▼) to select a setting, and press the OK button.

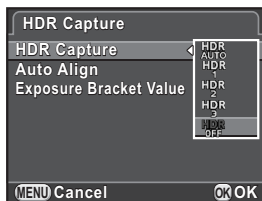

- 3** Use the four-way controller (▲▼) to select [Auto Align], and use the four-way controller (◀▶) to select or .

<input checked="" type="checkbox"/>	Uses Auto Align. Activates Shake Reduction according to the [Shake Reduction] setting. (default setting)
<input type="checkbox"/>	Does not use Auto Align. Deactivates Shake Reduction.

- 4** Use the four-way controller (▲▼) to select [Exposure Bracket Value], and press the four-way controller (▶).

- 5** Use the four-way controller (▲▼) to set the range in which to change the exposure, and press the OK button.

Select from ± 1 EV, ± 2 EV (default setting) or ± 3 EV.

- 6** Press the MENU button twice.

The camera is ready to take a series of pictures.



- The procedure of Step 2 can also be performed through the control panel.
- When both Shake Reduction and Auto Align are activated, take note of the following points.
 - Make sure to hold the camera firmly so that the composition of the picture does not change while the three images are captured. If there is a great difference of the composition between three images, Auto Align may not be possible.
 - Images captured with HDR Capture are susceptible to camera shake and blur. Be sure to set a higher shutter speed and a higher ISO sensitivity.
 - When the sensitivity is set to [ISO AUTO], the sensitivity can be raised more easily than normal.
 - Auto Align may not be possible when lenses that have a focal length exceeding 100 mm are used, or when the entire subject is checkered or has a uniform surface.
- In (Night Scene HDR) mode, [HDR Capture] is fixed to [Auto] and the Auto Align function is enabled.
- If [One Push File Format] is assigned to the RAW/Fx button, pressing the button temporarily deactivates HDR Capture and saves captured images in RAW+.

Lens Correction

Reduces distortions and lateral chromatic aberrations occurring due to lens properties.

● Distortion

Distortion is a phenomenon in which the center of the image appears inflated (barrel distortion) or the center of the image appears pinched (pincushion distortion). Distortion occurs more easily when using a zoom lens or a small diameter lens, and straight walls or the horizon in an image appear curved.

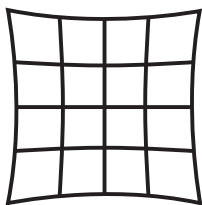

Pincushion distortion

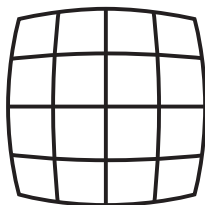

Barrel distortion

● Lateral chromatic aberration

Lateral chromatic aberration is a phenomenon in which the magnification of an image varies according to the colors (wavelengths of light) when a picture was taken, and may cause a blurred image. Chromatic aberration occurs more easily at shorter focal lengths.

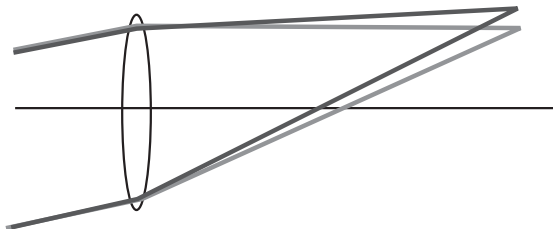



- Corrections can only be made when using DA, DA L, D FA or some FA lenses. The Lens Correction functions cannot be selected when an incompatible lens is attached. (p.261)
- The Lens Correction functions are disabled when using an accessory such as a close-up ring or rear converter that is attached between the camera and the lens.
- The shooting speed for Continuous Shooting may be slower when using the Distortion Correction function.
- The effects of the Lens Correction functions may be barely noticeable in some cases due to the shooting conditions or other factors.

1 Press the INFO button in standby mode.

The control panel appears.

2 Use the four-way controller (▲▼◀▶) to select [Distortion Correction] or [Lat-Chromatic-Ab Adj], and press the OK button.

The [Distortion Correction] or [Lat-Chromatic-Ab Adj] screen appears.

3 Use the four-way controller (◀▶) to select [Off] or [On].

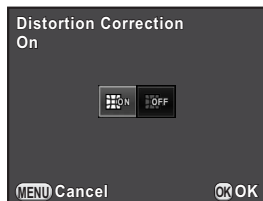

4 Press the OK button.

The camera returns to the control panel.



- When a compatible lens is attached and the file format is set to [RAW] or [RAW+], the correction information is saved as a RAW file parameter and you can select [On] or [Off] when developing the RAW images. (p.199)
- You can also set [Distortion Correction] and [Lat-Chromatic-Ab Adj] in [Lens Correction] of the [Rec. Mode 2] menu.

Composition Adjustment

It allows you to adjust the composition of your image using the Shake Reduction mechanism. Use this when you want to adjust the composition, such as when using a tripod.

- 1 Select [Composition Adjust.] in the [📷 Rec. Mode 3] menu, and press the four-way controller (▶).**

The [Composition Adjust.] screen appears.

- 2 Select [Start adjustment], and press the OK button.**

To start adjusting the composition from the previous position, set [Recall Previous Position] to .

Live View is displayed and the composition can be adjusted.

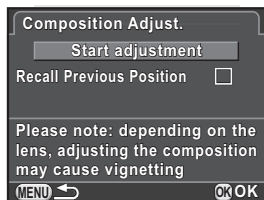

- 3 Adjust the composition.**

The amount of adjustment (the number of steps) is displayed at the top right of the screen.

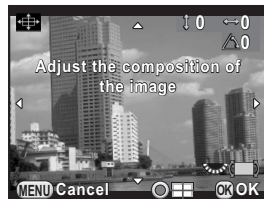

Available operations

Four-way controller (▲▼◀▶)	Moves the composition up, down, left or right. Adjust up to 16 steps (approximately ± 1.0 mm) on the image sensor.
Rear e-dial (🔍)	Adjusts the level of the composition. Up to 8 steps (approximately $\pm 1^\circ$) can be adjusted.
⊙ button	Resets the adjustment value to the default setting.

4 Press the OK button.

The camera returns to normal Live View and is ready to take a picture.



- Shake Reduction and Horizon Correction are not available.
- The adjustment value is reset when Live View is ended.
- If you use the Composition Adjustment function frequently, you can assign the function to the **RAW/Fx** button. (p.167)

Take pictures with settings to suit for your creative photographic vision.

Custom Image

Select the desired picture style from the following modes and enjoy taking pictures with a creative finishing tone.

Image Tone	Image
Bright	Saturation, hue and contrast are set relatively high to create a bright sharp image. (default setting)
Natural	Creates a natural look that is close to the actual color.
Portrait	Reproduces a healthy and bright skin tone.
Landscape	Increases color saturation, highlights shapes, and produces a vivid color image.
Vibrant	Changes the color slightly to create an antique look.
Radiant	Emphasizes glossiness to produce a spectacular finish.
Muted	Reduces the saturation to create a soft look.
Bleach Bypass	Reduces the saturation and increases the contrast to create the look of an old picture.
Reversal Film	Creates a picture with strong image contrast as if taken with reversal film.
Monochrome	Takes pictures using a monochrome color filter.
Cross Processing	Intentionally changes the hue and contrast. The outcome varies each time a picture is taken.



The image tone is automatically set according to the capture mode and the setting cannot be changed in **AUTO** and **SCN** modes.

1

Press the INFO button in standby mode.

The control panel appears.

2 Use the four-way controller (▲▼◀▶) to select [Custom Image], and press the OK button.

The Custom Image setting screen appears.

The last image taken is displayed in the background.

3 Use the four-way controller (▲▼◀▶) to select an image finishing tone.

You can check the selected Custom Image effect with the background image.

Proceed to Step 8 if you do not need to change the parameters.

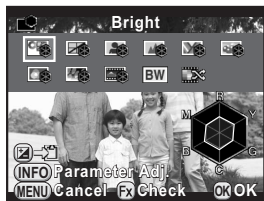

Available operations

button	Saves the background image (only when the data is available).
INFO button	Displays the screen to adjust the parameters.
RAW/Fx button	Uses Digital Preview to preview the background image with the Custom Image effect applied (only when shooting with the viewfinder).

4 Press the INFO button.

The screen to adjust the parameters appears.

5 Use the four-way controller (▲▼) to choose the parameter you want to change.

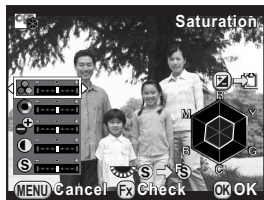

The following parameters can be changed according to the selected image finishing tone.

Image Tone	Parameter
Bright/ Natural/ Portrait/ Landscape/ Vibrant/ Radiant	Saturation: -4 to +4
	Hue: -4 to +4
	High/Low Key Adj: -4 to +4
	Contrast: -4 to +4
	Sharpness: -4 to +4
Muted/ Bleach Bypass	Saturation: -4 to +4
	Toning: Off/Green/Yellow/Orange/Red/Magenta/Purple/Blue/Cyan
	High/Low Key Adj: -4 to +4
	Contrast: -4 to +4
	Sharpness: -4 to +4
Reversal Film	Sharpness: -4 to +4
Monochrome	Filter Effect: None/Green/Yellow/Orange/Red/Magenta/Blue/Cyan/Infrared Filter
	Toning: Off/Green/Yellow/Orange/Red/Magenta/Purple/Blue/Cyan
	High/Low Key Adj: -4 to +4
	Contrast: -4 to +4
	Sharpness: -4 to +4
Cross Processing	Random/Preset 1-3/Favorite 1-3 ^{*1}

^{*1} For [Favorite 1-3], you can save the settings of a cross processed image as a favorite in advance through the playback mode palette. (p.160)

6 Use the four-way controller (◀▶) to adjust the parameter's value.

You can check the saturation and hue with the radar chart.

Available operations

Rear e-dial (☀️)	Switches between [Sharpness] and [Fine Sharpness].
⊙ button	Resets the adjustment value to the default setting.

7 Press the OK button.

The screen that was displayed in Step 3 appears again.

8 Press the OK button.

The camera returns to the control panel.



You can also change the settings from the [Rec. Mode 1] menu.

Saving the Cross Processing Settings of a Captured Image

The outcome of cross processing varies each time a picture is taken. If a cross processed image that you like comes out, you can save the Cross Processing settings used in that image. A total of three Cross Processing settings can be saved.

1 Press the four-way controller (▼) in the single image display of playback mode.

The playback mode palette appears.

2 Use the four-way controller (▲▼◀▶) to select (Save Cross Processing), and press the OK button.

The camera will search for cross processed images starting from the most recent image taken. (An hourglass icon is displayed while searching.) When a cross processed image is found, the screen to save the settings appears.

If there are no cross processed images, the message [No cross processed image] appears.

3 Turn the front e-dial (☀) to select a cross processed image.

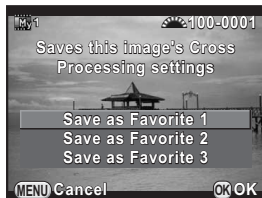



4 Use the four-way controller (▲▼) to select a number, and press the OK button.

The settings of the selected image are saved to [Favorite 1 - 3] and the selected image appears in the single image display.

Digital Filter

You can apply a filter effect when taking pictures.
The following filters can be selected.

Filter Name	Effect	Parameter
Extract Color	For extracting one or two specific colors and making the rest of the image black and white.	Extracted Color 1: Red/Magenta/Blue/Cyan/Green/Yellow
		Extractable Range of Color 1: 1 to 5
		Extracted Color 2: Off/Red/Magenta/Blue/Cyan/Green/Yellow
		Extractable Range of Color 2: 1 to 5
Toy Camera	For taking pictures that look as if taken with a toy camera.	Shading Level: Off/Low/Medium/High (Not available in  mode.)
		Blur: Low/Medium/High
		Tone Break: Red/Green/Blue/Yellow
Retro	For taking pictures with the look of old photos.	Toning (B-A): 7 levels
		Frame Composite: None/Thin/Medium/Thick (Not available in  mode.)
High Contrast	For taking pictures with high contrasts.	Intensity: 1 to 5
Shading ^{*1}	For taking pictures with the edge areas darkened.	Shading Type: 4 types
		Shading Level: -3 to +3
Invert Color	Inverts the colors in the image.	Off/On
Color	For taking pictures with the selected color filter.	Color: Red/Magenta/Blue/Cyan/Green/Yellow
		Color Density: Light/Medium/Dark

*1 Cannot be selected in  mode.



- Digital Filter is not available in the following situations.
 - when  (Night Scene HDR) of **SCN** mode is set
 - when the file format is set to [RAW] or [RAW+]
- When Digital Filter is set, the following functions are not available.
 - Continuous Shooting
 - Multi-exposure
 - HDR Capture
- Depending on the filter used, it may take longer to save images.

1 Press the INFO button in standby mode.

The control panel appears.

2 Use the four-way controller (▲▼◀▶) to select [Digital Filter], and press the OK button.

The Digital Filter setting screen appears.

The last image taken is displayed in the background.

3 Use the four-way controller (▲▼◀▶) to select a filter.

You can check the selected filter effect with the background image.

Proceed to Step 7 if you do not need to change the parameters.



Available operations

INFO button	Displays the screen to adjust the parameters.
☑ button	Saves the background image (only when the data is available).
RAW/Fx button	Uses Digital Preview to preview the background image with the filter effect applied (only when shooting with the viewfinder).

4 Press the INFO button.

The screen to adjust the parameters appears.

5 Use the four-way controller (▲▼) to select a parameter, and use the four-way controller (◀▶) to adjust the value.

Press the ○ button to reset the adjustment value to the default setting.



6 Press the OK button.

The screen that was displayed in Step 3 appears again.

7 Press the OK button.

The camera returns to the control panel.



- You can also change the settings from the [📷 Rec. Mode 1] menu.
- Select [No Filter] in Step 3 to finish shooting with a digital filter.
- After shooting, you can also apply digital filter effects to JPEG/RAW images in playback mode. (p.191)
- [Shading Level] for the Toy Camera filter and the Shading filter cannot be checked with Live View.

Customizing the Button/E-dial Functions

Functions can be assigned to the front/rear e-dial, **RAW/Fx** button, and **AF/AE-L** button.

The current functions assigned to the buttons/dials can be checked with guide display.



Setting the E-dials Operation

5

Shooting Settings

For each exposure mode, you can select the parameters for when the front and rear e-dials are turned and button is pressed.

- 1 **Select [E-Dial Programming] in the [Rec. Mode 4] menu, and press the four-way controller (right arrow).**

The [E-Dial Programming 1] screen appears.

- 2 **Use the four-way controller (up/down) to select an exposure mode.**

Turn the rear e-dial () to display the [E-Dial Programming 2] screen.



- 3 **Press the four-way controller (right arrow).**



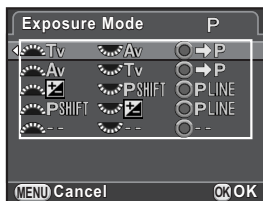

The screen for the selected exposure mode appears.

4 Press the four-way controller (▶), and use the four-way controller (▲▼) to select the desired setting.

The following settings can be selected for each exposure mode.



Exposure Mode	Front E-dial (☀)	Rear E-dial (☀)	⊙ Button	
P	Tv	Av	➡ P	(default setting)
	Av	Tv	➡ P	
	☒	P SHIFT	P LINE	
	P SHIFT	☒	P LINE	
	–	–	–	
Sv	–	ISO	–	(default setting)
	ISO	–	–	
	P SHIFT	ISO	P LINE	
	ISO	P SHIFT	P LINE	
	☒	ISO	–	
	ISO	☒	–	
Tv	Tv	–	–	(default setting)
	–	Tv	–	
	Tv	☒	–	
	☒	Tv	–	
	Tv	ISO	ISO AUTO	
	ISO	Tv	ISO AUTO	
Av	–	Av	–	(default setting)
	Av	–	–	
	☒	Av	–	
	Av	☒	–	
	ISO	Av	ISO AUTO	
	Av	ISO	ISO AUTO	

Exposure Mode	Front E-dial ()	Rear E-dial ()	⊙ Button		
TA_v/M	Tv	Av		(default setting)	
	Av	Tv			
				P LINE	(default setting)
				TvSHIFT	
				AvSHIFT	
	–				
B	–	Av	–	(default setting)	
	Av	–	–		
	ISO	Av	–		
	Av	ISO	–		
	Depends on the [Exposure Setting] (p.130) of the [ Movie 1] menu.				

Tv: Change shutter speed **Av**: Change aperture value **ISO**: Change sensitivity
: Adjust EV compensation value  **P**: Return to **P** **P LINE**: Program line
P SHIFT: Program shift –: Not available

5 Press the OK button.

6 Press the MENU button.

The screen that was displayed in Step 2 appears again.

Repeat Steps 2 to 6 to change the settings of other exposure modes.

7 Press the MENU button twice.

The screen that was displayed before selecting the menu item appears again.

Setting the RAW/Fx Button Operation

You can assign one of the following functions to the **RAW/Fx** button.

One Push File Format	Temporarily changes the file format. Simultaneously saves an image in both JPEG and RAW formats, regardless of the [File Format] setting. You can set whether or not to apply the setting to only one image, and select the file format when the RAW/Fx button is pressed. (p.168) (default setting)
Exposure Bracketing	Takes multiple pictures with different exposure settings. (p.93)
Optical Preview	While the RAW/Fx button is pressed, you can check the depth of field by stopping down the aperture to the set value. (p.114)
Digital Preview	Displays the Digital Preview. (p.115) Sets whether to save or magnify the preview image, and whether to display the histogram and bright/dark area warning.
Composition Adjust.	Adjusts the composition. (p.155)
AF Active Area	Enables or disables changing the AF point when the focus point selection mode is set to [Select]. (p.105)

5

- 1 **Select [Button Customization] in the [Rec. Mode 4] menu, and press the four-way controller (▶).**

The [Button Customization] screen appears.

- 2 **Select **RAW/Fx**, and press the four-way controller (▶).**

The screen to select a function of the **RAW/Fx** button appears.

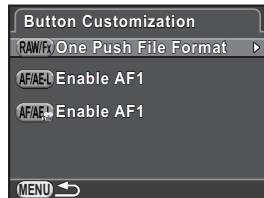

- 3 **Press the four-way controller (▶), use the four-way controller (▲▼) to select a function, and press the OK button.**

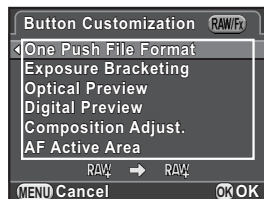

4 Press the MENU button three times.

The screen that was displayed before selecting the menu item appears again.

Setting the One Push File Format

When [One Push File Format] is assigned to the RAW/Fx button, specify the function settings.

1 Select [One Push File Format] in Step 3 on p.167.

2 Use the four-way controller (▲▼) to select [Cancel after 1 shot], and use the four-way controller (◀▶) to select or .

<input checked="" type="checkbox"/>	The recording format returns to the original file format after a picture is taken. (default setting)
<input type="checkbox"/>	The setting is canceled when any of the following operations are performed. <ul style="list-style-type: none"> • the RAW/Fx button is pressed again • the  button or MENU button is pressed • the mode dial is turned

3 Use the four-way controller (▲▼) to choose a file format.

The left side is the [File Format] (p.143) setting and the right side is the file format when the RAW/Fx button is pressed.

4 Press the four-way controller (▶), use the four-way controller (▲▼) to select a file format, and press the OK button.

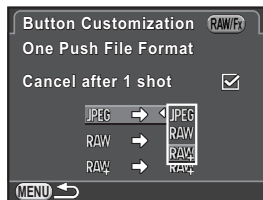

5 Press the MENU button three times.

The screen that was displayed before selecting the menu item appears again.

Setting the AF/AE-L Button Operation

You can assign one of the following functions to the **AF/AE-L** button. Separate settings can be made for still picture shooting and movie recording.

Enable AF1	Both the AF/AE-L button and shutter release button are available to perform autofocus. (p.101) (default setting)
Enable AF2	Autofocus is performed only when the AF/AE-L button is pressed and not when the shutter release button is pressed halfway.
Cancel AF	While the AF/AE-L button is pressed, autofocus is not performed even when the shutter release button is pressed. Take your finger off the AF/AE-L button to return to normal autofocus operation.
AE Lock	The exposure setting is locked when the AF/AE-L button is pressed. (p.96)

- 1 Select **[Button Customization]** in the **[CAMERA Mode 4]** menu, and press the four-way controller (▶).

The [Button Customization] screen appears.

- 2 Use the four-way controller (▲▼) to select **(AF/AE-L)**, and press the four-way controller (▶).

The **AF/AE-L** button icon with  is the setting for movie recording. The screen to select a function of the **AF/AE-L** button appears.

- 3 Press the four-way controller (▶), use the four-way controller (▲▼) to select a function, and press the OK button.

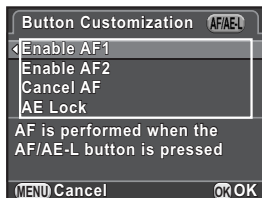

- 4 Press the **MENU** button three times.

The screen that was displayed before selecting the menu item appears again.

You can save the current camera settings in **USER** mode and easily retrieve them.

The following settings can be saved.

- Capture mode (**P/Sv/Tv/Av/TAv/M/B**)
- Sensitivity
- White Balance
- Flash Mode/Flash Exposure Compensation
- Drive Mode
- Exposure Bracketing
- Exposure Compensation Value
- Digital Filter
- Custom Image
- HDR Capture
- File Format
- JPEG Recorded Pixels
- JPEG Quality
- Color Space
- AE Metering
- AF.A
- AF point
- Lens Correction
- D-Range Settings
- High-ISO NR
- Slow Shutter Speed NR
- Shake Reduction/ Horizon Correction
- E-Dial Programming
- Button Customization
- [**C** Custom Setting 1-4] menu settings

5

Shooting Settings



The **USER** mode cannot be set when the mode dial is set to **AUTO**, **SCN** or

Saving the Settings

You can save the settings as **USER1** or **USER2** mode and use them by setting the mode dial to **U1** or **U2**.

- 1 Select a capture mode, and make the necessary settings.
- 2 Select [**Save USER Mode**] in the [**Rec. Mode 4**] menu, and press the four-way controller (**▶**).

The [Save USER Mode] screen appears.

- 3** Press the four-way controller (▶).

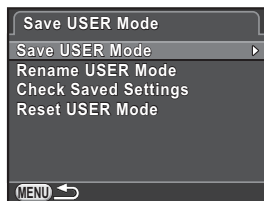

- 4** Use the four-way controller (▲▼) to select [USER1] or [USER2], and press the four-way controller (▶).

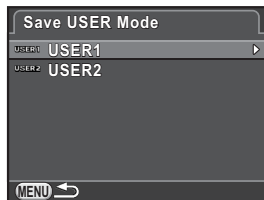

- 5** Press the four-way controller (▲) to select [Save], and press the OK button.

The settings are saved and the screen that was displayed in Step 3 appears again.

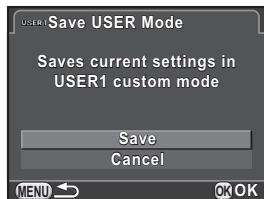

Editing a Setting Name

You can change the name of the **USER** mode in which you saved settings.

- 1** Select [Rename USER Mode] in Step 3 of “Saving the Settings”, and press the four-way controller (▶).

The [Rename USER Mode] screen appears.

- 2** Use the four-way controller (▲▼) to select [USER1] or [USER2], and press the four-way controller (▶).

The text-entry screen appears.

3

Enter the text.

Up to 18 single-byte alphanumeric characters and symbols can be entered.

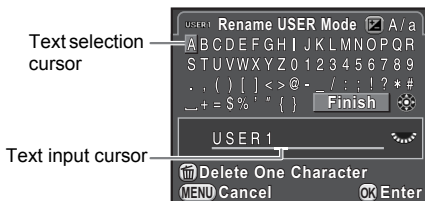
**Available operations**

Four-way controller (▲▼◀▶)	Moves the text selection cursor.
Rear e-dial (☀)	Moves the text input cursor.
☑ button	Switches between upper and lower case letters.
OK button	Enters a character selected with the text selection cursor at the position of the text input cursor.
LV /☒ button	Deletes a character at the position of the text input cursor.

4

After entering the text, move the text selection cursor to [Finish], and press the OK button.

The name is changed and the camera returns to the [Rename USER Mode] screen.

Checking the Saved USER Settings

- 1 Select [Check Saved Settings] in Step 3 of p.171, and press the four-way controller (▶).

The [Check Saved Settings] screen appears.

- 2 Use the four-way controller (▲▼) to select [USER1] or [USER2], and press the four-way controller (▶).

The current settings saved as **USER** mode are displayed.

Use the four-way controller (▲▼) to switch between pages.



- 3 Press the **OK** button.

The camera returns to the [Save USER Mode] screen.

Using Saved USER Settings

You can easily retrieve saved settings.

- 1 Set the mode dial to **U1** or **U2**.

The **USER** mode guide appears for 30 seconds and the saved settings are retrieved.

Use the four-way controller (▲▼) to check the saved settings.



2 Change the settings as necessary.

The capture mode can be changed in [Exposure Mode] of the [Rec. Mode 1] menu.

This screen appears only when the mode dial is set to **U1** or **U2**.

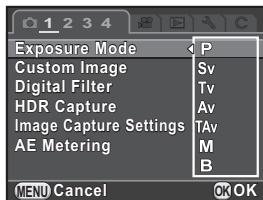

3 Take a picture.



The settings changed in Step 2 are not saved as **USER** mode settings. When the camera is turned off, the camera returns to the originally saved settings. To change the original settings, save the **USER** mode settings again.

Resetting to Default Settings

Resets the settings saved as **USER** mode to the default settings.

1 Select [Reset USER Mode] in Step 3 on p.171, and press the four-way controller (▶).

The [Reset USER Mode] screen appears.

2 Use the four-way controller (▲▼) to select [USER1] or [USER2], and press the four-way controller (▶).

3 Press the four-way controller (▲) to select [Reset], and press the OK button.

The **USER** mode settings return to the default values and the screen that was displayed before selecting the menu item appears again.

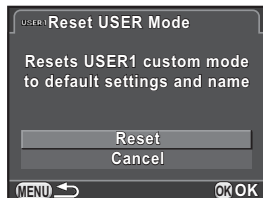

6 Playback Functions and Image Editing

This chapter describes how to use the various playback functions and how to edit the captured images.

How to Operate the Playback/Edit Functions	176
Setting the Playback Display Method	178
Selecting the Playback Functions	179
Deleting Multiple Images	186
Processing Images	189
Developing RAW Images	198
Connecting the Camera to an AV Device	202

How to Operate the Playback/Edit Functions

Make settings related to playing back and editing images in the playback mode palette or [▶ Playback] menu.



For details on how to use the menus, refer to “Using the Menus” (p.40).



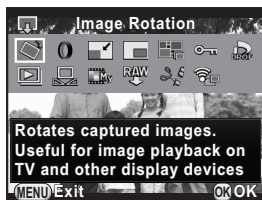

Playback Mode Palette Items

Press the four-way controller (▼) in the single image display to call up the playback mode palette.

You can also display the playback mode palette when a movie is paused.



Item	Function	Page
◊ Image Rotation *1	Changes the rotation information of an image.	p.185
⓪ Digital Filter *1	Modifies an image with various filter effects which, for example, change the color tone of an image and produce a soft or slim appearance.	p.191
📐 Resize *1 *2	Changes the number of recorded pixels or size of an image, and saves it as a new image.	p.189
📏 Cropping *1	Crops out only the desired area of the picture and saves it as a new image.	p.190
📑 Index *1	Joins a number of images together and creates a new image with them.	p.196
🔑 Protect	Protects images from being accidentally erased.	p.222
🖨️ DPOF *1 *2	Sets the number of prints and whether to print the date on the images saved on the SD Memory Card.	p.231
▶ Slideshow	Plays back the images one after another.	p.184

Item	Function	Page
 Save as Manual WB *1	Saves the white balance settings of a captured image as Manual White Balance.	p.148
 Save Cross Processing	Saves the settings for an image captured in Cross Processing mode of Custom Image to Favorite.	p.160
 RAW Development *1	Converts a RAW image to JPEG format and saves it as a new image.	p.198
 Movie Edit *3	Divides a movie and deletes unwanted segments.	p.138
 Eye-Fi Image Transfer *4	Transfers selected images wirelessly using an optional Eye-Fi card.	p.229

*1 This cannot be performed when a movie is displayed.

*2 This cannot be performed when a RAW image is displayed.

*3 This can be performed only when a movie is displayed.

*4 This can be performed only when [Eye-Fi Communication] is set to [SELECT] in [Eye-Fi] of the [Set-up 2] menu.

Playback Menu Items

The following items are available in the [▶ Playback] menu.

Press the **MENU** button in playback mode to display the [▶ Playback 1] menu.

Menu	Item	Function	Page
▶1	Slideshow	Plays back images one after another. You can set how images will be displayed in the slideshow.	p.183
	Quick Zoom	Sets the initial magnification when magnifying images.	p.178
	Bright/Dark Area	Sets whether to display the bright/dark area warning during playback.	
	Auto Image Rotation	Sets whether to rotate images when playing back images captured with the camera held vertically or images for which the rotation information was changed to the vertical position.	
	Delete All Images	Deletes all saved images at once.	p.188

Setting the Playback Display Method

You can set the initial magnification when magnifying images in the single image display (p.179), whether to display the bright/dark area warning, and whether to automatically rotate images that are captured with the camera held vertically.

1 Select [Quick Zoom] in the [▶ Playback 1] menu, and press the four-way controller (▶).

2 Use the four-way controller (▲▼) to select the magnification, and press the OK button.

Select from [x16], [x8], [x4], [x2] or [Off] (default setting).



3 Use the four-way controller (▲▼) to select [Bright/Dark Area] or [Auto Image Rotation], and use the four-way controller (◀▶) to select or .

Bright/Dark Area	Bright (overexposed) portions blink red and dark (underexposed) portions blink yellow. (p.34)
Auto Image Rotation	During playback, the image is automatically rotated based on the rotation information when [18. Save Rotation Info] in the [C Custom Setting 3] menu is set to [On].

4 Press the MENU button.

The screen that was displayed before selecting the menu item appears again.



The bright/dark area warning is not displayed in Detailed Information Display and RGB Histogram Display. (p.30)

You can display images in a list or play back saved images successively.

Magnifying Images

Images can be magnified up to 16 times in playback mode.

1 Select an image in the single image display.

2 Turn the rear e-dial (☀️) to the right (toward 🔍).

The image is magnified with each click (1.2 to 16 times).



Available operations

Rear e-dial (☀️) to the right (🔍)	Magnifies the image (up to 16 times).
Rear e-dial (☀️) to the left (🔍)	Reduces the image (up to 1 times).
Four-way controller (▲▼◀▶)	Changes the display area.
Front e-dial (☀️)	Retains the magnification and the position of the display area and shows the previous/next image.
⊙ button	Returns the position of the display area to the center (when the display area is not at the center).
INFO button	Switches between [Standard Information Display] and [No Information Display].
OK button	Returns to the single image display.



- The default setting for the first click is 1.2 times. You can change this in [Quick Zoom] of the [▶ Playback 1] menu. (p.178)
- The initial full display of vertical images is displayed with a magnification of 0.75 times that of horizontal images. Therefore, magnification at the first click starts at 1 times.

Displaying Multiple Images

- 1 Turn the rear e-dial (☀️) to the left (toward 📁) in the single image display.

The 9 thumbnail display screen appears (default setting).



- 2 Turn the rear e-dial (☀️) to the left (toward 📁) again to switch to the folder display.

Images are grouped and displayed by the folder in which they are saved.



- 3 Select the image(s) to display.

Available operations

Four-way controller (▲▼◀▶)	Moves the selection frame.
LV /🗑️ button	Deletes the selected images. (p.186)
OK button	Displays the selected image in the single image display. Displays the first image from the selected folder in the single image display (in Folder Display).

- 4 Turn the rear e-dial (☀️) to the right (toward 🔍).

The camera returns to the single image display.

Changing the Multiple Image Display Style

You can change the number of images displayed at the same time, or display the images by shooting date.

1 Press the INFO button in Step 1 on p.180.

The display style selection screen appears.

2 Use the four-way controller (▲▼◀▶) to select the display style.



4/9/16/36/81 Thumbnail Display

Icons such as and are displayed with images (except in 81 Thumbnail Display).



Number of images shot on this date



Shooting
date

Thumbnail
date

Available operations

Four-way controller (▲▼)	Selects a shooting date.
Four-way controller (◀▶)	Selects an image taken on the selected shooting date.
Rear e-dial (☀) to the right (Q)	Displays the selected image in the single image display. Turn to the left (☀) to return to the Calendar Filmstrip Display.

3

Press the OK button.

The selected display style is confirmed.

The next time the rear e-dial (☀) is turned to the left (toward ☀) in the single image display, the screen selected here will be displayed.

Playing Back Images Continuously

You can play back all images saved on your SD Memory Card successively in a slideshow.

Setting the Slideshow Display

Sets how images will be displayed during Slideshow.

- 1 Select [Slideshow] in the [▶ Playback 1] menu, and press the four-way controller (▶).

The Slideshow setting screen appears.

- 2 Use the four-way controller (▲▼) to select an item you want to change.

The following items can be changed.

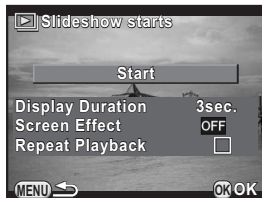

Item	Description	Setting
Display Duration	Select an image display duration.	3sec. (default setting)/ 5sec./10sec./30sec.
Screen Effect	Select a transition effect when the next image is displayed.	OFF (default setting)/ Fade/Wipe/Stripe
Repeat Playback	Set whether to start the slideshow again from the beginning after the last image is displayed.	<input type="checkbox"/> (default setting)/ <input checked="" type="checkbox"/>

- 3 Press the four-way controller (▶), use the four-way controller (▲▼) to change the setting, and press the OK button.

Starting the Slideshow

- 1 Select [Start] in Step 2 on p.183, and press the **OK** button. Or, select  (Slideshow) in the playback mode palette, and press the **OK** button.

The start screen is displayed and the slideshow starts.



Available operations

OK button	Pauses/resumes playback.
Four-way controller (◀)	Displays the previous image.
Four-way controller (▶)	Displays the next image.

- 2 Press the four-way controller (▼).

Slideshow stops and the single image display reappears.

After slideshow ends, the camera returns to the single image display even if you do not press the four-way controller (▼).



For movies, only the first frame is displayed and then the next image is displayed after the set display duration has elapsed. To play a movie during a slideshow, press the **OK** button while the first frame is displayed. After the playback of the movie is finished, the slideshow will resume.

Rotating Images

You can rotate captured images during playback.

If you set the camera so that it saves images with rotation information at the time of shooting, even when you take pictures with the camera held vertically, the images can be played back with the correct image orientation.

The rotation information of an image can be changed by following the procedure below.



- When [18. Save Rotation Info] in the [C Custom Setting 3] menu is set to [Off], image rotation information is not saved when shooting.
- When [Auto Image Rotation] (p.178) in the [▶ Playback 1] menu is enabled, images with rotation information are automatically rotated during playback.



- You cannot change the rotation information of an image in the following conditions.
 - when the image is protected
 - when the image rotation information tag is not saved with the image
 - when [Auto Image Rotation] (p.178) of the [▶ Playback 1] menu is disabled
- Movie files cannot be rotated.

1

Select the image you want to rotate in the single image display, and press the four-way controller (▼).

The playback mode palette appears.

2

Use the four-way controller (▲▼◀▶) to select  (Image Rotation), and press the OK button.

The selected image is rotated in 90° increments and the four thumbnail images are displayed.

3

Use the four-way controller (▲▼◀▶) to select the desired rotation direction, and press the OK button.

The image rotation information is saved.

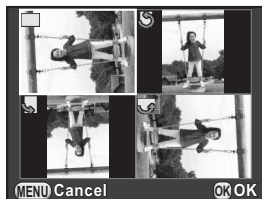

You can delete multiple images at once. Be aware that deleted images cannot be restored.

☞ Protecting Images from Deletion (Protect) (p.222)

Deleting Selected Images

You can delete multiple images at once.



- Protected images cannot be selected.
- You can select up to 100 images at a time.

1 Turn the rear e-dial (☀️) to the left (toward ☒) in the single image display.

The 9 thumbnail display screen appears (default setting).

2 Press the **LV** / 🗑️ button.

The screen to select images to delete is displayed.

3 Select images to delete.



Available operations

Four-way controller Moves the selection frame.

(▲▼◀▶)

OK button Confirms/cancels the image selection.

Rear e-dial (☀️) Displays the selected image in the single image display when turned to the right; returns to thumbnail display when turned to the left.

Turn the front e-dial (☀️) to display the previous or next image.



4 Press the  button.

The delete confirmation screen appears.

5 Use the four-way controller ( ) to select [Select & Delete], and press the **OK** button.

The selected images are deleted.



Deleting a Folder

1 Turn the rear e-dial () two clicks to the left (toward ) in the single image display.



The folder display screen appears.

2 Press the  button.

The delete confirmation screen appears.

3 Use the four-way controller ( ) to select [Delete], and press the **OK** button.

The selected folder and all images in it are deleted.

The confirmation screen appears when there are protected images. Use the four-way controller ( ) to select [Delete all] or [Leave all] and press the **OK** button. [Delete all] deletes all the images including the protected images, while [Leave all] deletes only non-protected images.

Deleting All Images

You can delete all images saved on the SD Memory Card at once.

- 1** Select **[Delete All Images]** in the **[▶ Playback 1]** menu, and press the four-way controller (**▶**).

The confirmation screen for deleting all images is displayed.

- 2** Press the four-way controller (**▲**) to select **[Delete All Images]**, and press the **OK** button.

All images are deleted.

The confirmation screen appears when there are protected images. Use the four-way controller (**▲▼**) to select **[Delete all]** or **[Leave all]** and press the **OK** button.

[Delete all] deletes all the images including the protected images, while **[Leave all]** deletes only non-protected images.

Changing the Number of Recorded Pixels (Resize)

Changes the number of recorded pixels of a selected image, and saves it as a new image.



- Only JPEG images captured with this camera can be resized.
- Images already resized to 0.3M or 0.2M with this camera cannot be resized.

- 1** Select the image to resize in the single image display, and press the four-way controller (▼).

The playback mode palette appears.

- 2** Use the four-way controller (▲▼◀▶) to select  (Resize), and press the OK button.

The screen to select the recorded pixels appears.

- 3** Use the four-way controller (◀▶) to select the number of recorded pixels, and press the OK button.

You can select one of the image sizes starting from one size smaller than that of the original image.



- 4** Use the four-way controller (▲▼) to select [Save as], and press the OK button.

The resized image is saved as a new image.

Cutting Out Part of the Image (Cropping)

Crops out only the desired area of a selected image and saves it as a new image.



- Only JPEG images captured with this camera can be cropped.
- Images already resized to 0.3M or 0.2M with this camera cannot be cropped.

1 Select the image to crop in the single image display, and press the four-way controller (▼).

The playback mode palette appears.

2 Use the four-way controller (▲▼◀▶) to select [Cropping], and press the OK button.

The cropping frame to specify the size and position of the area to crop appears on the screen.

3 Specify the size and position of the area to crop by using the cropping frame.



Available operations

Four-way controller (▲▼◀▶)	Moves the cropping frame.
Rear e-dial (☀️)	Changes the size of the cropping frame.
INFO button	Changes the aspect ratio.
→ Four-way controller (▲▼◀▶)	Rotates the image from -45° to +45°.
☑️ button	Rotates the cropping frame in 90° increments (only when the cropping frame can be rotated).

4 Press the OK button.

The save confirmation screen appears.

5 Use the four-way controller (▲▼) to select [Save as], and press the OK button.

The cropped image is saved as a new image.

Processing Images with Digital Filters

You can edit captured images using digital filters.
The following filters are available.

Filter Name	Effect	Parameter
Monochrome	Creates a monochrome image.	Filter Effect: OFF/Red/Green/Blue/ Infrared Filter
		Toning (B-A): 7 levels
Extract Color	Extracts one or two specific colors and makes the rest of the image black and white.	Extracted Color 1: Red/Magenta/ Blue/Cyan/Green/Yellow
		Extractable Range of Color 1: 1 to 5
		Extracted Color 2: OFF/Red/ Magenta/Blue/Cyan/Green/Yellow
		Extractable Range of Color 2: 1 to 5
Toy Camera	Creates an image that looks as though it was shot with a toy camera.	Shading Level: OFF/Low/Medium/ High
		Blur: Low/Medium/High
		Tone Break: Red/Green/Blue/Yellow
Retro	Creates an image with the look of an old photo.	Toning (B-A): 7 levels
		Frame Composite: None/Thin/ Medium/Thick
High Contrast	Enhances the contrast in the image.	Intensity: 1 to 5
Shading	Creates an image with darkened edges.	Shading Type: 4 types
		Shading Level: -3 to +3
Invert Color	Inverts image colors.	OFF/ON
Color	Adds a color filter to the image.	Color: Red/Magenta/Blue/Cyan/ Green/Yellow
		Color Density: Light/Medium/Dark
Tone Expansion	Creates an image with a unique contrast.	Low/Medium/High
Sketch	Creates an image that looks as though it was drawn with a pencil.	Contrast: Low/Medium/High
		Scratch Effect: OFF/ON
Water Color	Creates an image that looks as though it was painted.	Intensity: Low/Medium/High
		Saturation: OFF/Low/Medium/High

Filter Name	Effect	Parameter
Pastel	Creates an image that looks as though it was drawn with a crayon.	Low/Medium/High
Posterization	Lessens the tone of the image to create an image that looks as though it was hand-drawn.	Intensity: 1 to 5
Miniature	Blurs part of the image to create a simulated miniature scene.	In-Focus Plane: -3 to +3
		In-Focus Width: Narrow/Middle/Wide
		In-Focus Plane Angle: Horizon/Vertical/Positive Slope/Negative Slope
		Blur: Low/Medium/High
Soft	Creates an image with a soft focus throughout the image.	Soft Focus: Low/Medium/High
		Shadow Blur: OFF/ON
Starburst	Creates an image with a special sparkling look by adding extra glitter to the highlights of night scenes	Effect Density: Small/Medium/Large
		Size: Small/Medium/Large
		Angle: 0°/30°/45°/60°
Fish-eye	Creates an image that looks as though it was shot with a fish-eye lens.	Low/Medium/High
Slim	Changes the horizontal and vertical ratio of images.	-8 to +8
Base Parameter Adj	Adjusts the parameters to create the desired image.	Brightness: -8 to +8
		Saturation: -3 to +3
		Hue: -3 to +3
		Contrast: -3 to +3
		Sharpness: -3 to +3



Only JPEG and RAW images captured with this camera can be edited with digital filters.

- 1 Select an image for applying the digital filter in the single image display, and press the four-way controller (▼).**

The playback mode palette appears.

- 2 Use the four-way controller (▲▼◀▶) to select 0 (Digital Filter), and press the OK button.**

The screen to select a filter appears.

- 3 Use the four-way controller (▲▼◀▶) to select a filter.**

You can check the selected filter effect with the background image.

You can select a different image by turning the front e-dial (☀).

Proceed to Step 7 if you do not need to change the parameters.



- 4 Press the INFO button.**

The screen to adjust the parameters appears.

- 5 Use the four-way controller (▲▼) to select a parameter and the four-way controller (◀▶) to adjust the value.**



- 6 Press the OK button.**

The screen that was displayed in Step 3 appears again.

- 7 Press the OK button.**

The save confirmation screen appears.

- 8** Use the four-way controller (▲▼) to select [Apply additional filter(s)] or [Save as], and press the OK button.

Select [Apply additional filter(s)] when you want to apply additional filters to the same image. The screen that was displayed in Step 3 appears again.

If [Save as] is selected, the filter-processed image is saved as a new image.



Up to 20 filters, including a digital filter used during shooting (p.161), can be applied to the same image.

Recreating Filter Effects

Retrieves the filter effects of a selected image and applies the same filter effects to other images.

- 1** Select a filter-processed image in the single image display.
- 2** Select **0** (Digital Filter) in the playback mode palette, and press the OK button.
- 3** Use the four-way controller (▲▼) to select [Recreating filter effects], and press the OK button.

The filter effects used for the selected image appear.

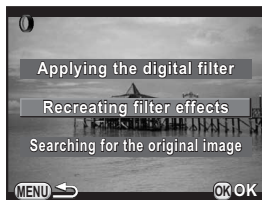

4 To check the parameter details, press the INFO button.

You can check the filter parameters.

Press the **MENU** button to return to the previous screen.

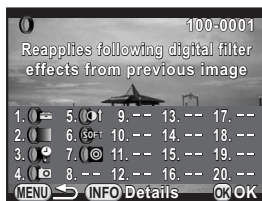

5 Press the OK button.

The image selection screen appears.

6 Turn the front e-dial (☀) to select the image to apply the same filter effects, and press the OK button.

You can only select the image that has not been processed with a filter.

The save confirmation screen appears.



7 Use the four-way controller (▲▼) to select [Save as], and press the OK button.

The filter-processed image is saved as a new image.



If [Searching for the original image] is selected in Step 3, the original image prior to digital filter application can be retrieved. If the original image is no longer stored on the SD Memory Card, the message [Original image, prior to digital filter application, is not found] appears.

Joining Multiple Images (Index)

Join a number of images together and display them as an index image. You can have the camera select the images to include in the index image or you can select them yourself. The images will be randomly arranged or displayed by file number depending on the layout selected.







- 1 Press the four-way controller (▼) in the single image display.**

The playback mode palette appears.

- 2 Use the four-way controller (▲▼◀▶) to select  (Index), and press the OK button.**

The Index setting screen appears.

- 3 Press the four-way controller (▶), use the four-way controller (▲▼) to select a layout, and press the OK button.**

You can select  (Thumbnail),  (Square),  (Random1),  (Random2),  (Random3) or  (Bubble).

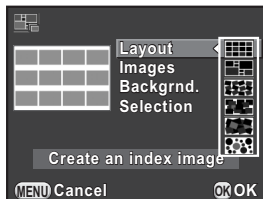

Images are displayed according to the file number (from the smallest number) for , and are displayed in random order for other layouts.

- 4 Use the four-way controller (▲▼) to select [Images], and press the four-way controller (▶).**

- 5 Use the four-way controller (▲▼) to select the number of images, and press the OK button.**

You can select 12, 24 or 36 images.

When the number of saved images is smaller than the number selected, empty spaces will appear when [Layout] is set to  and some images may be duplicated for other layouts.





- 6 Use the four-way controller (▲▼) to select [Backgrnd.], and press the four-way controller (▶).**

- 7** Use the four-way controller (▲▼) to select the background color, and press the OK button.

You can select a white or black background.

- 8** Use the four-way controller (▲▼) to select [Selection], and press the four-way controller (▶).



- 9** Use the four-way controller (▲▼) to select a type of image selection, and press the OK button.

 Auto	Picks images automatically from all of the images saved.
 Manual	Lets you select images you want to include in the index image. If  is selected, [Select image(s)] appears and leads you to the image selection screen.
 Folder name	Picks images automatically from the folder selected. If  is selected, [Select a folder] appears and leads you to the folder selection screen.

- 10** Use the four-way controller (▲▼) to select [Create an index image], and press the OK button.

The index image is created and a confirmation screen appears.

- 11** Use the four-way controller (▲▼) to select [Save] or [Reshuffle], and press the OK button.

Save	Saves the index image as a  (3072×2048) and ★★★ file.
Reshuffle	Reselects the images to be included in the index image and displays a new index image. However, if  is selected for [Layout], this item is not displayed.

After the index image is saved, the camera returns to playback mode and the index image is displayed.



Processing may take a while when creating an index image.

You can convert captured RAW images into JPEG images, and save them as new files.



Only RAW images captured with this camera can be edited. RAW images captured with other cameras cannot be edited on this camera.

Developing One RAW Image

- 1 Select a RAW image in the single image display, and press the four-way controller (▼).**

The playback mode palette appears.

- 2 Use the four-way controller (▲▼◀▶) to select RAW (RAW Development), and press the OK button.**

The screen to select a development method is displayed.

- 3 Use the four-way controller (▲▼) to select [Developing a single image], and press the OK button.**

The parameters saved in the image file appear.

Proceed to Step 6 if you do not need to change the parameters.

If there are no images that can be processed, [No image can be processed] appears.



- 4 Use the four-way controller (▲▼) to choose the parameter you want to change.**

You can select a different image by turning the front e-dial (☀️).



The following parameters can be changed.

Parameter	Value	Page
Image Capture Settings	Aspect Ratio (16:9 / 3:2 / 4:3 / 1:1), JPEG Recorded Pixels *1, JPEG Quality, Color Space	p.143
Lens Correction	Distortion Correction/Lateral Chromatic Aberration Adjustment (This can be selected only for images taken with a compatible lens. (p.261))	p.153
Custom Image	Bright/Natural/Portrait/Landscape/Vibrant/Radiant/Muted/Bleach Bypass/Reversal Film/Monochrome/Cross Processing	p.157
White Balance	AWB/////// //CTE/	p.145
Sensitivity	-2.0 to +2.0	—
High-ISO NR	Off/Auto/Low/Medium/High	p.98
Shadow Correction	Off/Auto/Low/Medium/High	p.150

*1 Select the JPEG recorded pixels corresponding to the aspect ratio.

5 Use the four-way controller (◀▶) to change the value.

For Image Capture Settings and Lens Correction, press the four-way controller (▶) and use the four-way controller (▲▼) to select an item. For Custom Image and White Balance, press the four-way controller (▶) to display the setting screen.

6 Press the OK button.

The save confirmation screen appears.

7 Use the four-way controller (▲▼) to select [Save as], and press the OK button.

The RAW image is developed and saved as a new JPEG image.

8 Use the four-way controller (▲▼) to select [Continue] or [Exit], and press the OK button.

Select [Continue] to edit other images. The screen that was displayed in Step 4 appears again.

Developing Multiple RAW Images

You can develop multiple RAW images with the same settings.

1 Select [Developing multiple images] in Step 3 on p.198, and press the OK button.

Images are displayed in [4 Thumbnail Display], [9 Thumbnail Display], [16 Thumbnail Display] or [36 Thumbnail Display] (the display style that was selected last).

2 Select the RAW images to be developed.

Available operations

Four-way controller Moves the selection frame.

(▲▼◀▶)

OK button Confirms/cancels the image selection.

Rear e-dial (☀) Displays the selected image in the single image display. Turn the front e-dial (☀) to display the previous or next image.

3 Press the INFO button.

The development confirmation screen appears.

4 Use the four-way controller (▲▼) to select [Develop images as shot] or [Develop images with modified settings], and press the OK button.

To change parameters, select [Develop images with modified settings].



5 Use the four-way controller (▲▼◀▶) to set [JPEG Recorded Pixels] and [JPEG Quality].

When [Develop images as shot] is selected in Step 4, select [16M], [12M], [8M] or [5M] for [JPEG Recorded Pixels].

When [Develop images with modified settings] is selected, refer to p.199 to change other parameters. All images are developed with the same settings.

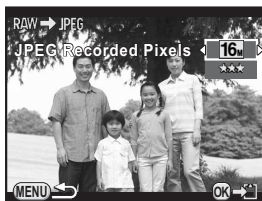

6 Press the OK button.

The save confirmation screen appears.

7 Use the four-way controller (▲▼) to select [Save as], and press the OK button.

The selected RAW images are developed and saved as new JPEG images.

Connecting the Camera to an AV Device

You can connect the camera to a TV or other device and play back captured images.



- For an AV device with multiple video input terminals, check the operating manual of the device, and select a suitable video input terminal for connecting the camera.
- If you intend to use the camera continuously for a long period, use of the optional AC adapter kit is recommended.

Connecting the Camera to a Video Input Terminal

You can connect the camera to a device with a video input terminal. Use the optional AV cable I-AVC7.

- 1 Turn the AV device and camera off.
- 2 Open the terminal cover of the camera, and connect the AV cable to the VIDEO/PC output terminal.

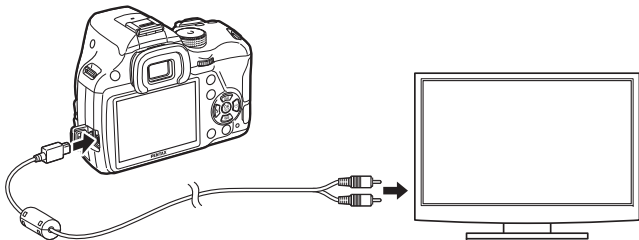

- 3 Connect the other end of the cable to the input terminal on the AV device.

4 Turn the AV device and camera on.

The camera turns on in video mode, and the camera information is displayed on the screen of the connected AV device.



- You cannot adjust the volume on the camera while the camera is connected to an AV device. Adjust the volume on the AV device.
- Movies are played back with monaural sound.
- Images are output at normal resolution regardless of the resolution supported by the AV device. To output HD video, transfer to and play back on a computer.

Setting the Video Output Format

When the hometown is set at the time of initial setting (p.58), the video output format is set in accordance with that region. Depending on the country or region, images may fail to be played back with the set video output format. If this happens, change the setting.

1 Select [Interface Options] in the [Set-up 2] menu, and press the four-way controller (▶).

The [Interface Options] screen appears.

2 Use the four-way controller (▲▼) to select [Video Out], and press the four-way controller (▶).

3 Use the four-way controller (▲▼) to select [NTSC] or [PAL], and press the OK button.

4 Press the MENU button twice.

The screen that was displayed before selecting the menu item appears again.



The video output format differs depending on the region. When you set [Time Setting] in the World Time setting (p.209) to (Destination), the video output setting changes to the video output format for that city. Refer to "List of World Time Cities" (p.211) for cities that can be selected as a hometown or destination.

Memo

7 Changing Additional Settings

This chapter describes how to change additional settings.





How to Operate the Set-up Menu	206
Camera Settings	208
File Management Settings	221



The [ Set-up] menu offers you general settings related to the camera.



For details on how to use the menus, refer to "Using the Menus" (p.40).

Set-up Menu Items

The following items are available in the [ Set-up 1-4] menus. Press the **MENU** button in capture/playback mode, and use the four-way controller ( ) or rear e-dial () to display the [ Set-up 1-4] menus.

Menu	Item	Function	Page	
 1	Language/言語	Changes the language in which menus and messages appear.	p.58	
	Date Adjustment	Sets the date format and time.	p.60	
	World Time	Sets the display of the local date and time of the specified city so they can be displayed on the monitor in addition to the present location.	p.209	
	Text Size	Sets the text size of an item selected on the respective menu screens.	p.59	
	Sound Effects	Switches the operation sound on/off and changes its volume.	p.208	
	LCD Display	Sets the guide display and display color of the screen.	p.212	
	LCD Display Settings	Adjusts the brightness and the color of the monitor.	p.213	
 2	Flicker Reduction	Cuts down on screen flicker by setting the power frequency to that used in your region.	p.27	
	Interface Options	Video Out	Sets the output format when connecting to an AV device with a video input terminal.	p.203
		USB Connection	Sets the USB connection mode when connecting to a computer.	p.235
	Folder Name	Sets the naming system for folders to store images.	p.223	

Menu	Item	Function	Page
2	Create New Folder	Creates a new folder on the SD Memory Card.	p.224
	File Name	Sets the method used to assign file names for images.	p.225
	Copyright Information	Sets the photographer and copyright information embedded in Exif.	p.226
	Eye-Fi	Sets when using an Eye-Fi card.	p.228
3	Auto Power Off	Sets the time until the camera turns off automatically.	p.216
	AA Battery Type	Selects the type of AA batteries used for the optional battery holder.	p.216
	Reset	Resets all settings.	p.219
4	Pixel Mapping	Maps out and corrects any defective pixels on the CMOS sensor.	p.215
	Dust Removal	Cleans the CMOS sensor by shaking it.	p.266
	Sensor Cleaning	Locks the mirror in the up position for cleaning the CMOS sensor with a blower.	p.267
	Format	Formats an SD Memory Card.	p.221
	Firmware Info/Options	Displays the camera's firmware version.	p.220

Setting the Sound Effects, Date and Time, and Display Language

Setting the Sound Effects

You can turn the camera operation sound on or off, or change its volume. The sound for the following items can be set.

- In-focus
- AE-L (AE Lock operation sound)
- Self-timer
- Remote Control
- One Push File Format (operation sound when [One Push File Format] is assigned to the **RAW/Fx** button)
- Press OK for 1 sec. (operation sound when changing AF point is enabled or disabled)

7

1 Select **[Sound Effects]** in the **[ Set-up 1]** menu, and press the four-way controller (**▶**).

The [Sound Effects 1] screen appears.

2 Use the four-way controller (**◀▶**) to adjust the volume.

Select from six levels. When set to  (0), you can turn all the sound effects off.

3 Use the four-way controller (**▲▼**) to select an item, and use the four-way controller (**◀▶**) to select or .

Turn the rear e-dial () to display the [Sound Effects 2] screen.

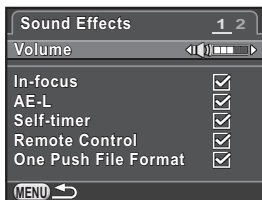

4 Press the **MENU** button twice.

The screen that was displayed before selecting the menu item appears again.

Setting the World Time

The date and time set in "Initial Setting" (p.58) serve as the date and time of your present location. Setting the destination in [World Time] enables you to display the local date and time on the monitor when traveling abroad.

- 1** Select [World Time] in the [**Set-up 1**] menu, and press the four-way controller (**▶**).

The [World Time] screen appears.

- 2** Use the four-way controller (**◀▶**) to select **→ (Destination)** or **⬆ (Hometown)** for [Time Setting].

This setting is reflected in the date and time that appear in the control panel.



- 3** Press the four-way controller (**▼**) to select [**→ Destination**], and press the four-way controller (**▶**).

The [**→ Destination**] screen appears.

- 4** Use the four-way controller (**◀▶**) to select a destination city.

Turn the rear e-dial () to change the region.

The location, time difference and current time of the selected city appear.

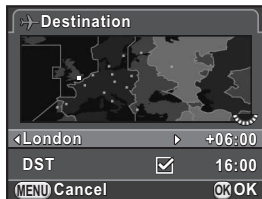

- 5** Press the four-way controller (**▼**) to select [DST], and use the four-way controller (**◀▶**) to select or .

Select if the destination city uses daylight saving time (DST).

- 6** Press the OK button.

The destination setting is saved and the screen that was displayed in Step 2 appears again.

7 Press the MENU button twice.

The screen that was displayed before selecting the menu item appears again.



- Refer to "List of World Time Cities" (p.211) for cities that can be selected as a destination or hometown.
- Select [Hometown] in Step 3 to change the city and DST setting.
- appears in the control panel if [Time Setting] is set to [Destination]. Also, the video output setting (p.203) changes to the video output format for that city.

● List of World Time Cities

Region	City	Video Output Format	Region	City	Video Output Format
North America	Honolulu	NTSC	Africa/ West Asia	Istanbul	PAL
	Anchorage	NTSC		Cairo	PAL
	Vancouver	NTSC		Jerusalem	PAL
	San Francisco	NTSC		Nairobi	PAL
	Los Angeles	NTSC		Jeddah	PAL
	Calgary	NTSC		Tehran	PAL
	Denver	NTSC		Dubai	PAL
	Chicago	NTSC		Karachi	PAL
	Miami	NTSC		Kabul	PAL
	Toronto	NTSC		Male	PAL
	New York	NTSC		Delhi	PAL
Halifax	NTSC	Colombo	PAL		
Central and South America	Mexico City	NTSC	Kathmandu	PAL	
	Lima	NTSC	Dacca	PAL	
	Santiago	NTSC	East Asia	Yangon	NTSC
	Caracas	NTSC		Bangkok	PAL
	Buenos Aires	PAL		Kuala Lumpur	PAL
	Sao Paulo	PAL		Vientiane	PAL
Rio de Janeiro	NTSC	Singapore		PAL	
Europe	Lisbon	PAL		Phnom Penh	PAL
	Madrid	PAL		Ho chi Minh	PAL
	London	PAL		Jakarta	PAL
	Paris	PAL		Hong Kong	PAL
	Amsterdam	PAL		Beijing	PAL
	Milan	PAL	Shanghai	PAL	
	Rome	PAL	Manila	NTSC	
	Copenhagen	PAL	Taipei	NTSC	
	Berlin	PAL	Seoul	NTSC	
	Prague	PAL	Tokyo	NTSC	
	Stockholm	PAL	Guam	NTSC	
	Budapest	PAL	Oceania	Perth	PAL
	Warsaw	PAL		Adelaide	PAL
	Athens	PAL		Sydney	PAL
	Helsinki	PAL		Noumea	PAL
Moscow	PAL	Wellington		PAL	
Africa/ West Asia	Dakar	PAL		Auckland	PAL
	Algiers	PAL	Pago Pago	NTSC	
	Johannesburg	PAL			

Setting the Monitor and the Menu Displays

Setting the Electronic Level Display

The bar scale of the electronic level can be displayed in the viewfinder or Live View screen. Set in [Electronic Level] of the [CAM Rec. Mode 3] menu.

<input type="checkbox"/>	Does not display the bar scale of the electronic level. (default setting)
<input checked="" type="checkbox"/>	Displays the bar scale of the electronic level.

Setting the LCD Display

You can set the display color of the guide display, status screen, control panel and menu selection cursor.

- 1 Select [LCD Display] in the [CAM Set-up1] menu, and press the four-way controller (▶).

The [LCD Display] screen appears.

- 2 Use the four-way controller (◀▶) to select or for [Guide Display].

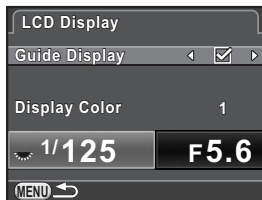

- 3 Use the four-way controller (▲▼) to select [Display Color], and use the four-way controller (◀▶) to select from twelve display colors.

- 4 Press the MENU button twice.

The screen that was displayed before selecting the menu item appears again.

Adjusting the Brightness and the Color of the Monitor

Adjusts the brightness and the color of the monitor.

- 1 Select [LCD Display Settings] in the [↖ Set-up 1] menu, and press the four-way controller (▶).

The [LCD Display Settings] screen appears.

- 2 Use the four-way controller (▲ ▼) to select [Brightness Level], [Adjust: Blue-Amber], or [Adjust: Green-Magenta].

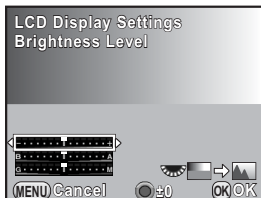

Brightness Level	Changes the brightness of the monitor (-7 to +7).
Adjust: Blue-Amber	Adjusts the tone of the colors between blue (B7) and amber (A7).
Adjust: Green-Magenta	Adjusts the tone of the colors between green (G7) and magenta (M7).

- 3 Use the four-way controller (◀ ▶) to adjust the value.

Available operations

Rear e-dial (📷)	Displays a captured image in the background.
⊙ button	Resets the adjustment value to the default setting.

- 4 Press the OK button.

- 5 Press the MENU button.

The screen that was displayed before selecting the menu item appears again.

Setting the Display for Instant Review

You can set the operation and display settings during Instant Review (p.66).

- 1 Select [Instant Review] in the [📷 Rec. Mode 4] menu, and press the four-way controller (▶).

The [Instant Review] screen appears.

- 2 Press the four-way controller (▶), use the four-way controller (▲▼) to select a display time, and press the OK button.



- 3 Use the four-way controller (▲▼) to select [Enlarge Instant Review], [Save RAW Data], [Histogram Display] or [Bright/Dark Area], and use the four-way controller (◀▶) to select or .

Enlarge Instant Review	You can magnify the image on the monitor with the rear e-dial (📷). (p.179)
Save RAW Data	Sets whether to save the RAW image by pressing the <input checked="" type="checkbox"/> button when the file format of the last captured image is JPEG and its RAW data still remains in the buffer memory. (p.72)
Histogram Display	Shows the brightness distribution of an image. (p.33)
Bright/Dark Area	Bright (overexposed) portions blink red and dark (underexposed) portions blink yellow. (p.34)

- 4 Press the MENU button twice.

The screen that was displayed before selecting the menu item appears again.

Setting the Initial Menu Tab to be Displayed

Set the initial menu tab displayed on the monitor when the **MENU** button is pressed.

- 1 Select **[19. Save Menu Location]** in the **[C Custom Setting 3]** menu, and press the four-way controller (▶).

The [19. Save Menu Location] screen appears.

- 2 Use the four-way controller (▲▼) to select **[Reset Menu Location]** or **[Save Menu Location]**, and press the **OK** button.

Reset Menu Location	The [📷 Rec. Mode 1] menu ([🎬 Movie 1] menu in 🎬 mode, and [▶ Playback 1] menu in playback mode) is always displayed first. (default setting)
Save Menu Location	The menu tab last selected is displayed first.

- 3 Press the **MENU** button.

The screen that was displayed before selecting the menu item appears again.

Correcting Defective Pixels in the CMOS Sensor (Pixel Mapping)

Pixel Mapping is a function for mapping out and correcting defective pixels in the CMOS sensor.

Attach a proper lens to the camera before using Pixel Mapping.

- 1 Select **[Pixel Mapping]** in the **[↖ Set-up 4]** menu, and press the four-way controller (▶).

The [Pixel Mapping] screen appears.

- 2 Press the four-way controller (▲) to select **[Pixel Mapping]**, and press the **OK** button.

Defective pixels are mapped out and corrected, and the screen that was displayed before selecting the menu item appears again.



- It takes about 30 seconds to map out and correct the defective pixels.
- When the battery level is low, [Not enough battery power remaining to activate Pixel Mapping] is displayed on the monitor. Install a fully charged battery, or use the optional AC adapter kit.

Battery Settings

Minimizing Battery Consumption

You can set the camera to turn off automatically if unused after a certain length of time.

Set in [Auto Power Off] of the [**Set-up 3**] menu. Select from [1min.] (default setting), [3min.], [5min.], [10min.], [30min.], or [Off].



- Perform any of the following operations to reactivate the camera from Auto Power Off.
 - Turn the camera off and on again.
 - Press the shutter release button halfway.
 - Press the **MENU** button or **INFO** button.
- Auto Power Off does not function in the following situations:
 - when a slideshow is played back
 - when the camera is connected to an AV device with a USB cable
 - while transferring images via Eye-Fi card

Setting the Battery Type

Sets the type of AA batteries used in the optional AA Battery Holder D-BH109. The default setting is [Auto-detect].

- 1** Select [**AA Battery Type**] in the [**Set-up 3**] menu, and press the four-way controller (**▶**).

The [AA Battery Type] screen appears.

- 2** Use the four-way controller (**▲ ▼**) to select a battery type, and press the **OK** button.

When set to [Auto-detect], the camera will automatically detect the type of batteries being used.

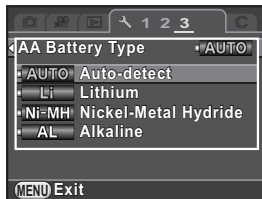

3 Press the MENU button.

The screen that was displayed before selecting the menu item appears again.



When the type of batteries actually being used is different from the item you selected here, the battery level will not be correctly determined. Please set the correct battery type. Usually, there is no problem using [Auto-detect], however it may take a while to detect the battery type. In low temperatures and when using batteries that were stored for long periods of time, set the appropriate battery type so the camera can correctly determine the remaining battery level.

Selecting Settings to Save in the Camera (Memory)

You can select which function settings to save when the camera is turned off. The following function settings can be saved.

Function	Default Setting
Flash Mode	<input checked="" type="checkbox"/>
Drive Mode	<input checked="" type="checkbox"/>
White Balance	<input checked="" type="checkbox"/>
Custom Image	<input checked="" type="checkbox"/>
Sensitivity	<input checked="" type="checkbox"/>
EV Compensation	<input checked="" type="checkbox"/>

Function	Default Setting
Flash Exposure Comp.	<input checked="" type="checkbox"/>
Digital Filter	<input type="checkbox"/>
HDR Capture	<input type="checkbox"/>
Shooting Info Display	<input type="checkbox"/>
Playback Info Display	<input checked="" type="checkbox"/>
File No.	<input checked="" type="checkbox"/>



This setting cannot be performed when the mode dial is set to **U1** or **U2**.

1 Select [Memory] in the [📷 Rec. Mode 4] menu, and press the four-way controller (▶).

The [Memory 1] screen appears.

2 Use the four-way controller (▲▼) to select an item, and use the four-way controller (◀▶) to select or .

Turn the rear e-dial (🔘) to display the [Memory 2] screen.

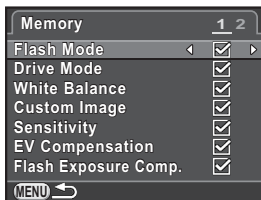

<input checked="" type="checkbox"/>	Settings are saved even when the camera is turned off.
<input type="checkbox"/>	Settings are returned to their default values when the camera is turned off.

3 Press the MENU button twice.

The screen that was displayed before selecting the menu item appears again.



- In [Shooting Info Display], you can set whether to save the type of information displayed in standby mode. (p.29)

<input type="checkbox"/>	The status screen is always displayed first when the camera is turned on.
<input checked="" type="checkbox"/>	The display selected from the Shooting Info Display selection screen (other than [Electronic Compass]) appears when the camera is turned on.

- Set [File No.] to to continue the sequential numbering (four digits) for the file name even if a new folder is created.

<input checked="" type="checkbox"/>	The file number of the last image saved to the previous folder is saved and subsequent images are assigned sequential file numbers even if a new folder is created.
<input type="checkbox"/>	The file number of the first image saved to a folder returns to 0001 each time a new folder is created for saving images.

- When [Reset] of the [🔘 Set-up 3] menu is performed, all Memory settings return to the default values. (p.219)

Resetting the Camera Settings

Resets the settings you selected in the menu screen to the default values.



You cannot reset the settings when the mode dial is set to **U1** or **U2**.

Resetting the Rec. Mode/Movie/Playback/Set-up Menus

Settings of the direct keys and for the items of the [📷 Rec. Mode] menu, [🎞️ Movie] menu, [▶ Playback] menu, [⚙️ Set-up] menu, and playback mode palette can be reset to default values.

- 1 Select [Reset] in the [⚙️ Set-up 3] menu, and press the four-way controller (▶).**

The [Reset] screen appears.

- 2 Press the four-way controller (▲) to select [Reset], and press the OK button.**

The settings are reset, and the screen that was displayed before selecting the menu item appears again.



The following settings are not reset.

- Saved USER mode settings
- Language/言語
- Date Adjustment
- The city and DST settings for World Time
- Flicker Reduction
- Video Out
- Copyright Information
- [C Custom Setting] menu items

Resetting the Custom Menu

Settings for the items of the [C Custom Setting] menu can be reset to default values.

- 1 Select [Reset Custom Functions] in the [C Custom Setting 4] menu, and press the four-way controller (▶).**

The [Reset Custom Functions] screen appears.

2 Press the four-way controller (▲) to select [Reset], and press the OK button.

The settings are reset, and the screen that was displayed before selecting the menu item appears again.

Checking the Camera Version Information

You can check the version information for software (firmware) in the camera. If an update file for the firmware is released, you can update the camera to the latest firmware version.



Visit our website for more information and procedural details regarding updates.

1 Select [Firmware Info/Options] in the [↶ Set-up 4] menu, and press the four-way controller (▶).

The firmware version for the camera is displayed on the [Firmware Info/Options] screen.

At this point, if an update file is saved on your SD Memory Card, you can run the update.



2 Press the MENU button twice.

The screen that was displayed before selecting the menu item appears again.



- You cannot restore a camera to its previous firmware version after updating it.
- Before running the update, be sure to save the data on your SD Memory Card to a computer or other location.
- When the battery level is low, [Not enough battery power remaining to update the firmware] is displayed on the monitor. Install a fully charged battery, or use the optional AC adapter kit.

Formatting an SD Memory Card

Use this camera to format (initialize) an SD Memory Card that is unused or has been used on other devices.

Formatting deletes all the data saved on the SD Memory Card.



- Do not remove the SD Memory Card while formatting. The card may be damaged and become unusable.
- Formatting deletes all data, both protected and unprotected.

1 Select [Format] in the [↖ Set-up 4] menu, and press the four-way controller (▶).

The [Format] screen appears.

2 Press the four-way controller (▲) to select [Format], and press the OK button.

Formatting starts.

When formatting is completed, the screen that was displayed before selecting the menu item appears again.

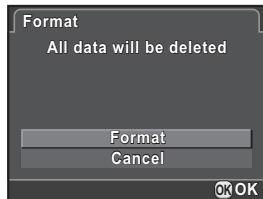

When an SD Memory Card is formatted, the volume label assigned to the card is "K-50". When this camera is connected to a computer, the SD Memory Card is recognized as a removable disk with the name "K-50".

Protecting Images from Deletion (Protect)

You can protect images from being accidentally deleted.



Even protected images are deleted if the inserted SD Memory Card is formatted.

1 Press the four-way controller (▼) in the single image display of playback mode.

The playback mode palette appears.

2 Use the four-way controller (▲▼◀▶) to select (Protect), and press the OK button.

The screen to select how to change the settings is displayed.

3 Use the four-way controller (▲▼) to select [Single image] or [All images], and press the OK button.

If you selected [All images], proceed to Step 5.



4 Turn the front e-dial (☀️) to select an image.

5 Press the four-way controller (▲) to select [Protect], and press the OK button.

Select [Unprotect] to cancel the protection of the image.

The image is protected and the  icon appears at the top right of the screen. Repeat Steps 4 and 5 to protect other images.

If you selected [All images] in Step 3, the camera returns to the single image display.



6 Press the MENU button.

The camera returns to the single image display.

Setting the Naming System of the Folder

When images are captured with this camera, a folder is automatically created and the captured images are stored in the new folder. Each folder name consists of a sequential number from 100 to 999 and a string of 5 characters. The string of characters can be changed.

- 1 Select [Folder Name] in the [Set-up 2] menu, and press the four-way controller (▶).
- 2 Press the four-way controller (▶), use the four-way controller (▲ ▼) to select [Date] or [PENTX], and press the OK button.

Date	The two digits of the month and day on which the picture was taken are assigned as the folder name in the form of [xxx_MMDD]. (default setting) [MMDD] (month and day) appears according to the display format set in [Date Adjustment] (p.60). Example: 101_0125 (folder for images taken on January 25th)
PENTX	The folder name is assigned in the form of [xxxPENTX]. "PENTX" can be changed to a string of characters of your choice. Example: 101PENTX

If you selected [Date], proceed to Step 6.

- 3 Press the four-way controller (▼), select [***PENTX] and press the four-way controller (▶).

The text-entry screen appears.

- 4 Change the text.

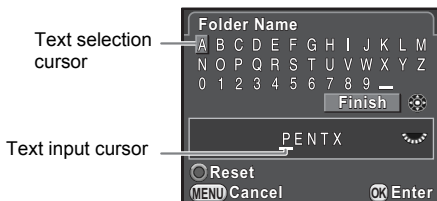

Available operations

Four-way controller (▲▼◀▶)	Moves the text selection cursor.
Rear e-dial (🔍)	Moves the text input cursor.
OK button	Enters a character selected with the text selection cursor at the position of the text input cursor.
⊙ button	Returns the folder name to [PENTX].

5 After entering the text, move the text selection cursor to [Finish], and press the OK button.

The folder name is changed.

6 Press the MENU button twice.

The screen that was displayed before selecting the menu item appears again.



A maximum of 500 images can be stored in a single folder. When the number of captured images exceeds 500, a new folder is created to store the additional images. In Exposure Bracketing shooting, images will be stored in the same folder until shooting is completed, even if the number of images exceeds 500.

Creating New Folders

You can create a new folder on the SD Memory Card. A folder is created with the number following the number of the folder currently being used. The newly created folder is used to store images starting with the next captured image.

1 Select [Create New Folder] in the [🔍 Set-up 2] menu, and press the four-way controller (▶).

The [Create New Folder] screen appears.

- Press the four-way controller (▲) to select [Create folder], and press the OK button.

A folder with a new number is created.



Only one folder can be created using this operation. Multiple empty folders cannot be created consecutively.

Setting the File Name

You can change the file names of images.

The default naming conventions are as follows depending on the [Color Space] (p.144) setting in [Image Capture Settings] of the [Rec. Mode 1] menu.

“xxxx” indicates the file number, and is displayed as a four-digit sequential number.

Color Space	File Name
sRGB	IMGPxxxx.JPG
AdobeRGB	_IMGxxxx.JPG

For sRGB, you can change [IMGPx] (4 characters) to the desired characters.

For AdobeRGB, of the 4 characters you selected, the first 3 are assigned in place of [IMG].

Example: When set to [ABCDxxxx.JPG], files are named
[_ABCxxxx.JPG] for AdobeRGB.

- Select [File Name] in the [Set-up 2] menu and press the four-way controller (▶).

The [File Name] screen appears.

- Press the four-way controller (▶).

The text-entry screen appears.

3 Change the text.

Enter the text in the same way as [Folder Name]. Refer to Steps 4 to 6 on p.223.

Selecting the File Number Setting

You can select a method for assigning the file number of an image when saved to a new folder. Set in [File No.] of [Memory] (p.217) in the [📷 Rec. Mode 4] menu.

<input checked="" type="checkbox"/>	The file number of the last image saved to the previous folder is saved and subsequent images are assigned sequential file numbers even if a new folder is created.
<input type="checkbox"/>	The file number of the first image saved to a folder returns to 0001 each time a new folder is created for saving images.

Setting the Photographer Information

The camera type, shooting conditions and other information are automatically embedded in captured images in Exif data format. You can embed photographer information in this Exif.



Use the provided software (p.237) to check the Exif information.

1 Select [Copyright Information] in the [🔍 Set-up 2] menu, and press the four-way controller (▶).

The [Copyright Information] screen appears.

2 Use the four-way controller (◀▶) to select or .

<input type="checkbox"/>	Does not embed copyright information in the Exif. (default setting)
<input checked="" type="checkbox"/>	Embeds copyright information in the Exif.

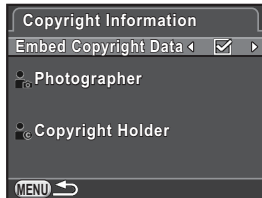

3 Use the four-way controller (▲▼) to select [Photographer], and press the four-way controller (▶).

The text-entry screen appears.

4 Enter the text.

Up to 32 single-byte alphanumeric characters and symbols can be entered.

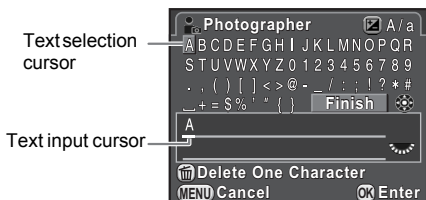

Available operations

Four-way controller (▲▼◀▶)	Moves the text selection cursor.
Rear e-dial (🔍)	Moves the text input cursor.
☑ button	Switches between upper and lower case letters.
OK button	Enters a character selected with the text selection cursor at the position of the text input cursor.
LV/🗑 button	Deletes a character at the position of the text input cursor.

5 After entering the text, move the text selection cursor to [Finish], and press the OK button.

The camera returns to the [Copyright Information] screen.

6 Use the four-way controller (▲▼) to select [Copyright Holder], and enter the text in the same way as [Photographer].

7 Press the MENU button twice.

The screen that was displayed before selecting the menu item appears again.

Using an Eye-Fi Card

You can transfer images to your computer via wireless LAN by using an SD Memory Card with a built-in wireless LAN (Eye-Fi card).



- Be sure to set up a wireless LAN access point on a computer in advance for the Eye-Fi card connection. It cannot be set up on the camera.
- Images are not transferred in the following cases:
 - when an image has already been transferred
 - when the size of a movie is 2 GB or more
 - when an Eye-Fi card is write protected
 - when a wireless LAN access point cannot be found
 - when the battery level is low (battery level is (red))
- For RAW images and movie files, the success of transfer depends on the specifications and settings of the Eye-Fi card in use.

1 Select [Eye-Fi] in the [Set-up 2] menu, and press the four-way controller (▶).

The [Eye-Fi] screen appears.

2 Use the four-way controller (▲▼) to select [Eye-Fi Communication], and press the four-way controller (▶).

3 Use the four-way controller (▲▼) to select the action, and press the OK button.

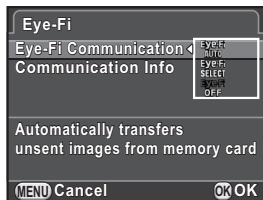

AUTO	Images that have not been transferred will be transferred automatically. Images will also be transferred when images are taken, new images are saved, or images are overwritten.
SELECT	Transfers the unsend images on the card that are selected in playback mode (p.229).
OFF	Turns off the wireless LAN function.

4 Press the MENU button twice.

The screen that was displayed before selecting the menu item appears again.



- When an Eye-Fi card is used, a new folder is created for every 100 images saved.
- Auto Power Off does not function when images are being transferred.
- When transferring a large number of images, use the optional AC adapter kit or install a fully charged battery. If the internal temperature of the camera becomes high during transferring images, the camera may be turned off automatically to protect the camera circuitry. In such a case, turn on the camera again after a while, and data transfer will resume.
- Select [Communication Info] in Step 2 on p.228 to check the firmware version of the Eye-Fi card.

Transferring Selected Images

When [SELECT] is set in Step 3 on p.228, only the selected images are transferred.

1 Press the four-way controller (▼) in the single image display of playback mode.

The playback mode palette appears.

2 Use the four-way controller (▲▼◀▶) to select (Eye-Fi Image Transfer), and press the OK button.

The screen to select the unit of transfer appears.

3 Use the four-way controller (▲▼) to select the unit of transfer, and press the OK button.

Select image(s)	<p>Enables selecting individual images (in one folder, up to 100 images).</p> <ul style="list-style-type: none"> • For images taken with [File Format] set to [RAW+], JPEG and RAW files saved are counted as one image, and both files are transferred.
Select a folder	<p>Transfers all of the images stored in the selected folder.</p> <ul style="list-style-type: none"> • Up to 100 images that can be transferred from the selected folder are transferred.

The folder selection screen appears.

4 Use the four-way controller (▲▼◀▶) to select the folder to transfer, and press the OK button.

When [Select image(s)] is selected, the screen to select the image(s) appears.

When [Select a folder] is selected, the transfer confirmation screen appears. Proceed to Step 7.

5 Select the image(s) to transfer.

Images with the , , or ? icon shown on the thumbnail cannot be selected.



Available operations

Four-way controller (▲▼◀▶)	Moves the selection frame.
Rear e-dial ()	Displays the selected image in the single image display when turned to the right; returns to thumbnail display when turned to the left.
OK button	Confirms/cancels the image selection.

6 Press the INFO button.

The images to be transferred are specified.

7 Use the four-way controller (▲▼) to select [Transfer], and press the OK button.

After the message [Transfer request accepted] appears, the camera returns to the single image display.



- Transferring process cannot be canceled once started.
- Only images captured in JPEG (.JPG) or RAW (.DNG) format can be selected. Movies and Interval Movies cannot be selected.

Setting the DPOF Settings

By adding DPOF (Digital Print Order Format) settings to stored images on the SD Memory Card, you can specify the number of copies and whether to imprint the date on the images in advance and order conventional photograph prints by taking this SD Memory Card to a store for printing.



- DPOF settings cannot be applied to RAW images and movies.
- You can make DPOF settings for up to 999 images.

1 Press the four-way controller (▼) in the single image display of playback mode.

The playback mode palette appears.

2 Use the four-way controller (▲▼◀▶) to select (DPOF), and press the OK button.

The screen to select how to change the settings is displayed.

3 Use the four-way controller (▲▼) to select [Single image] or [All images], and press the OK button.

If you selected [All images], proceed to Step 5.



4 Turn the front e-dial (☀) to select an image.



5 Use the four-way controller (▲▼) to select the number of copies.

You can set up to 99 copies.

 appears at the top right of the screen for images with DPOF settings. To cancel the DPOF settings, set the number of copies to [00].

6 Press the INFO button to select or for printing the date.

<input type="checkbox"/>	The date is not printed.
<input checked="" type="checkbox"/>	The date is printed.

Repeat Steps 4 to 6 to make DPOF settings for other images.

7 Press the OK button.

The DPOF settings for the selected image or all images are saved and the camera returns to the single image display.



- Depending on the printer or printing equipment at the photo processing lab, the date may not be printed on the pictures.
- The number of copies specified for all images is applied to all the images, and that specified for a single image is canceled.

8 Connecting to a Computer

This chapter explains how to connect the camera to a computer, install the supplied software on the CD-ROM, etc.

Manipulating Captured Images on a Computer	234
Saving Images on a Computer	235
Using the Provided Software	237

Manipulating Captured Images on a Computer

The captured still pictures and movies can be transferred to a computer by connecting the camera using a USB cable, and RAW images can be developed using the provided software “SILKYPIX Developer Studio 3.0 LE”.

When connecting the camera to a computer and using the software, we recommend using a computer with the following system requirements.

● Windows

OS	Windows XP (SP3 or later, 32-bit Home/Pro), Windows Vista (32-bit, 64-bit), Windows 7 (32-bit, 64-bit), Windows 8 (32-bit, 64-bit) <ul style="list-style-type: none"> • Installation requires administrator rights • Can be run as a 32-bit application on any 64-bit Edition of Windows
CPU	Intel Pentium-compatible processor (Pentium 4, Athlon XP or higher recommended) <ul style="list-style-type: none"> • Supports multi-core processors (Intel Core i5, i7; Core 2 Quad, Duo; AMD Phenom II X4, X6; Athlon II X2, X4; and other)
RAM	1 GB minimum (2 GB or more recommended)
HDD	For installing and starting up the program: 100 MB minimum of free space For saving image files: Approx. 10 MB/file
Monitor	1024×768 dots, 24-bit full color or higher
Others	Input devices such as a keyboard and mouse

● Macintosh

OS	Mac OS X 10.5, 10.6, 10.7 or 10.8
CPU	Intel processor-compatible, Power PC
RAM	1 GB minimum (2 GB or more recommended)
HDD	For installing and starting up the program: 100 MB minimum of free space For saving image files: Approx. 10 MB/file
Monitor	1024×768 dots, 24-bit full color or higher
Others	Input devices such as a keyboard and mouse



- Use the provided software to develop RAW images captured with this camera.
- QuickTime is required to play back movies transferred to a computer. You can download it from the following site:
<http://www.apple.com/quicktime/>

Setting the USB Connection Mode

Set the USB connection mode when connecting the camera to a computer.

- 1** Select [Interface Options] in the [ Set-up 2] menu, and press the four-way controller (▶).

The [Interface Options] screen appears.

- 2** Use the four-way controller (▲▼) to select [USB Connection], and press the four-way controller (▶).

- 3** Use the four-way controller (▲▼) to select [MSC] or [PTP], and press the OK button.

MSC	Mass Storage Class (default setting) A general-purpose driver program that handles devices connected to a computer via USB as a memory device.
PTP	Picture Transfer Protocol A protocol that allows transfer of digital images and control of digital cameras via USB.

Unless otherwise specified, select [MSC].

- 4** Press the MENU button twice.

The screen that was displayed before selecting the menu item appears again.

Connecting the Camera and a Computer

Connect the camera to a computer using the provided USB cable I-USB7.

- 1 Turn the computer on.**
- 2 Turn the camera off, and use the USB cable to connect the VIDEO/PC terminal of the camera and the computer.**

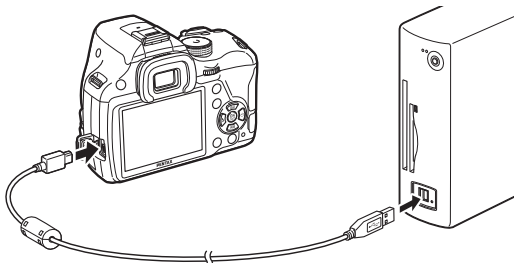

- 3 Turn the camera on.**

The camera is recognized as a removable disk or an SD Memory Card with a volume label "K-50".

If the "K-50" dialog appears when the camera is turned on, select [Open folder to view files using Windows Explorer] and click the OK button.

- 4 Save the captured images to the computer.**

Copy the image file(s) or folder(s) to the hard disk of the computer.

- 5 Disconnect the camera from the computer.**



The camera cannot be operated while it is connected to the computer. Turn off the camera and remove the USB cable to enable operating the camera.

“SILKYPIX Developer Studio 3.0 LE” is included on the CD-ROM (S-SW138). With the SILKYPIX Developer Studio 3.0 LE, you can develop RAW files, adjust the color of the images and other settings, and save the new images in JPEG or TIFF format.

Installing the Software

You can install the software from the provided CD-ROM. When multiple accounts have been set up on a computer, log on with an account that has administrative rights before installing the software.

1 Turn the computer on.

Make sure no other software is running.

2 Place the CD-ROM into the CD/DVD drive on the computer.

The [Software Installer] screen appears.

If the [Software Installer] screen does not appear

- **For Windows**

- 1 Click [My Computer] from the Start menu.
- 2 Double-click the [CD/DVD drive (S-SW138)] icon.
- 3 Double-click the [Setup.exe] icon.

- **For Macintosh**

- 1 Double-click the CD/DVD (S-SW138) icon on the desktop.
- 2 Double-click the [PENTAX Installer] icon.

3 Click [SILKYPIX Developer Studio 3.0 LE].

For Macintosh, follow the instructions on the screen to perform subsequent steps.

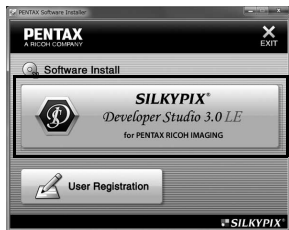

4 Select the desired language in the [Choose Setup Language] screen, and click [OK].

5 When the [InstallShield Wizard] screen appears in the selected language, click [Next].

Follow the instructions on the screen to perform subsequent steps.



Start SILKYPIX Developer Studio 3.0 LE and see the help menu for details on using the software program.

Regarding User Registration

To better serve you, please take a moment to register your software.

Click [User Registration] on the screen in Step 3 on p.238.



A world map for Internet User Registration is displayed. If the computer is connected to the Internet, click the displayed country or area and then follow the instructions to register your software.

Note that you can only register online if your country or area is shown.

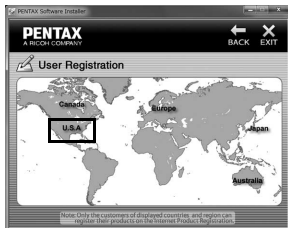

Memo

9 Using the Flash

This chapter provides details on the built-in flash and describes how to take pictures with an external flash.

Using the Built-in Flash	242
Using an External Flash (Optional)	245

Flash Characteristics in Each Exposure Mode

Using the Flash in Tv Mode



Any desired shutter speed of 1/180 sec. or slower can be set.

Using the Flash in Av Mode

The shutter speed automatically changes over a range from 1/180 sec. to a slow shutter speed that reduces camera shake (the slowest shutter speed depends on the focal length of the lens in use).

The shutter speed is locked at 1/180 sec. when a lens other than a DA, DA L, D FA, FA J, FA or F lens is used.

Using the Slow-speed Sync Flash



You can use Slow-speed Sync in  (Night Scene Portrait) of **SCN** mode or **Tv**, **TAv** or **M** mode when shooting portraits with the sunset in the background. Both the portrait and the background are captured beautifully.  and  can be used in **P**, **Sv** or **Av** mode.

Using P/Sv/Av Mode

1 Set the mode dial to **P**, **Sv** or **Av**.

2 Press the  button.

The built-in flash pops up.



3 Set the flash mode to  or .

The shutter speed is set slower to give a proper exposure for the background.

4 Take a picture.

Using Tv/TAv/M Mode

1 Set the mode dial to **Tv**, **TAv** or **M**.

2 Set the flash mode to  or .

3 Set the shutter speed (for **Tv** mode) or shutter speed and aperture value (for **TAv** or **M** mode).

Set so a proper exposure is obtained at a shutter speed of 1/180 seconds or slower.

4 Press the  button.

The built-in flash pops up.

5 Take a picture.

Distance and Aperture when Using the Built-in Flash

Relationships among the guide number, aperture and distance must be considered when shooting with the flash to obtain a correct exposure. Calculate the shooting distance or aperture value in the following way, and adjust the shooting conditions if the flash output is not sufficient.

ISO Sensitivity	Built-in Flash Guide Number	ISO Sensitivity	Built-in Flash Guide Number
ISO 100	Approx. 12	ISO 3200	Approx. 68
ISO 200	Approx. 17	ISO 6400	Approx. 96
ISO 400	Approx. 24	ISO 12800	Approx. 136
ISO 800	Approx. 34	ISO 25600	Approx. 192
ISO 1600	Approx. 48	ISO 51200	Approx. 272

Calculating Shooting Distance from Aperture Value

The following equation calculates the effective distance of the flash.

Maximum flash distance $L1 = \text{Guide number} \div \text{Aperture value}$

Minimum flash distance $L2 = \text{Maximum flash distance} \div 5^*$

* The value used in the formula above is a fixed value which applies only when using the built-in flash alone.

Example:

When the sensitivity is ISO 200 and the aperture value is F5.6:

$L1 = 17 \div 5.6 = \text{approx. } 3 \text{ (m)}$

$L2 = 3 \div 5 = \text{approx. } 0.6 \text{ (m)}$

Therefore, the flash can be used in a range of about 0.6 m to 3 m. However, the built-in flash in this camera cannot be used when the distance is 0.7 m or less. When the flash is used at distances closer than 0.7 m, it causes vignetting in the picture corners, light is distributed unevenly and the picture may be overexposed.

Calculating Aperture Value from Shooting Distance

The following equation calculates the correct aperture value.

Aperture value $F = \text{Guide number} \div \text{Shooting distance}$

Example:

When the sensitivity is ISO 200 and the shooting distance is 4 m:

$F = 17 \div 4 = \text{approx. } 4.2$

If the resulting number (4.2, in the above example) is not available as a lens aperture, a smaller number that is closest (4.0, in the above example) is generally used.

Using an optional external flash AF540FGZ, AF360FGZ, AF200FG or AF160FC enables a variety of flash modes such as P-TTL auto flash mode.

- ✓: Available
- #: Some functions are restricted.
- ×: Functions are unavailable.

Camera Function \ Flash	Built-in Flash	AF540FGZ AF360FGZ	AF200FG AF160FC
Red-eye reduction flash	✓	✓	✓
Auto flash discharge	✓	✓	✓
Automatically switching to the flash sync speed	✓	✓	✓
Aperture value is automatically set in P and Tv mode	✓	✓	✓
P-TTL auto flash	✓ ^{*1}	✓ ^{*1}	✓ ^{*1}
Slow-speed Sync	✓	✓	✓
Flash exposure compensation	✓	✓	✓
AF assist light of external flash	×	✓	×
Trailing Curtain Sync ^{*2}	✓	✓	×
Contrast control sync flash	# ^{*3}	✓	# ^{*4}
Slave flash	×	✓	×
High-speed sync	×	✓	×
Wireless flash	# ^{*4}	✓ ^{*5}	×

*1 Available only when using a DA, DA L, D FA, FA J, FA, F or A lens.

*2 Shutter speed of 1/90 sec. or slower.

*3 When combined with the AF540FGZ or AF360FGZ, 1/3 of the flash discharge can be output by the built-in flash and 2/3 can be output by the external flash.

*4 Available only when combined with the AF540FGZ or AF360FGZ.

*5 Multiple AF540FGZ or AF360FGZ units, or a combination of an AF540FGZ or AF360FGZ unit and the built-in flash is required.



- Flashes with reversed polarity (the center contact on the hot shoe is minus) cannot be used due to the risk of damaging the camera and/or flash.
- Do not combine with accessories that have a different number of contacts, such as a Hot Shoe Grip, as a malfunction may occur.
- Combining with flashes from other manufacturers may cause equipment breakdown. We recommend using the AF540FGZ, AF360FGZ or AF200FG.

Using the P-TTL Auto Flash

You can use the P-TTL auto flash with an AF540FGZ, AF360FGZ, AF200FG or AF160FC flash unit.

- 1 Remove the cover of the hot shoe, and attach the external flash.**
- 2 Turn on the camera and the external flash.**
- 3 Set the external flash mode to [P-TTL].**
- 4 Make sure that the external flash is fully charged, and then take a picture.**

The  will light in the viewfinder or Live View screen when the flash is ready (fully charged).



- For details such as operation method and effective distance, refer to the external flash manual.
- Never press the  button when any external flash unit is attached to the camera. The built-in flash will hit the external flash. If you want to use both at once, set the wireless mode or connect them using the extension cord. (p.250)

Using the High-speed Sync Flash

With an AF540FGZ or AF360FGZ flash unit, you can discharge a flash to take a picture at a shutter speed faster than 1/180 seconds.

- 1** Remove the cover of the hot shoe, and attach the external flash.
- 2** Set the mode dial to **Tv** or **M**.
- 3** Turn on the camera and the external flash.
- 4** Set the external flash sync mode to **HS**  (high-speed sync).
- 5** Make sure that the external flash is fully charged, and then take a picture.

The  will light in the viewfinder or Live View screen when the flash is ready (fully charged).



- High-speed sync is available only when the shutter speed is set faster than 1/180 sec.
- High-speed sync is not available in **B** mode.
- High-speed sync is not available with the built-in flash.

Using Flash in Wireless Mode

By using two external flashes (AF540FGZ or AF360FGZ) or using the built-in flash with one or more external flashes, you can shoot in P-TTL flash mode without connecting the flash units with a cord.



- Set the external flash to WIRELESS.
- Two or more AF540FGZ/AF360FGZ external flashes are required to use the high-speed sync flash in wireless mode. This function cannot be used in combination with the built-in flash.
- Set the wireless mode of the external flash not directly connected to the camera to SLAVE.

Setting the Channel for the External Flash

First, set the channel for the external flash unit.

1

Set the channel for the external flash unit.

2

Remove the cover of the hot shoe, and attach the external flash.

3

Turn on the camera and the external flash, and press the shutter release button halfway.

The built-in flash is set to the same channel as the external flash unit.



Be sure to set all the flashes to the same channel. Refer to the manual of the AF540FGZ or AF360FGZ for details on how to set the channel on the external flash.

Wireless Shooting Using a Combination of the Built-in Flash and an External Flash Unit

Set the camera to wireless flash mode when using an external flash in combination with the built-in flash.

1 Remove the external flash unit after the channel is set on the camera, and place it at the desired location.

2 Set the camera's flash mode to $w\text{⚡}$.

The camera is ready to take a picture.

The channel for the built-in flash is displayed in the viewfinder.

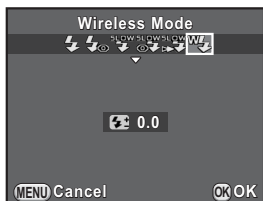

3 Press the ⚡ button.

4 Confirm that both flashes are fully charged, and then take a picture.



$w\text{⚡}$ is not available in the following situations.

- In Ⓜ mode
- when the drive mode is set to [Remote Control (3 sec. delay)]
- when the lens aperture ring is set to a position other than **A**



You can change the built-in flash discharge method used in wireless mode. Set in [17. Flash in Wireless Mode] of the [C Custom Setting 3] menu.

On	Discharges the built-in flash as a master flash. (default setting)
Off	Discharges the built-in flash as a control flash.

Wireless Shooting Using a Combination of External Flash Units

- 1 **Set the wireless mode of the external flash directly connected to the camera to [MASTER] or [CONTROL].**

MASTER	Discharge both the flash directly connected to the camera and the wireless flash unit as the main flash.
CONTROL	Discharges the flash directly connected to the camera as a control flash only, not as the main flash.

- 2 **On the wireless remote flash unit, set the wireless flash mode to [SLAVE] and set the channel to the same channel as the flash directly connected to the camera. Then, place it at the desired location.**

- 3 **Confirm that both flashes are fully charged, and then take a picture.**



- The Shake Reduction function is not available.
- When using multiple AF540FGZ/AF360FGZ external flashes and shooting with the high-speed sync flash in wireless mode, set the flash directly connected to the camera to high-speed sync flash mode.

Connecting an External Flash with an Extension Cord

When using an external flash away from the camera, attach the Hot Shoe Adapter F_G (①; optional) to the camera hot shoe and an Off-Camera Shoe Adapter F (②; optional) to the bottom of the external flash, and then connect these with the Extension Cord F5P (③; optional). The Off-Camera Shoe Adapter F can be mounted to your tripod using the tripod screw.

When combining with the built-in flash

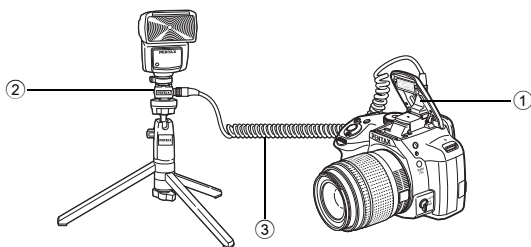

Multiple Flash Shooting Using Extension Cords

You can combine two or more external flashes (AF540FGZ, AF360FGZ or AF200FG).

For connecting an AF540FGZ flash unit, you can use the extension cord connection terminal on the flash. For connecting an AF360FGZ or AF200FG flash unit, as shown in the illustration, connect an external flash and the Hot Shoe Adapter F (④; optional) to the Off-Camera Shoe Adapter F (②; optional) and then connect another Off-Camera Shoe Adapter F (②) with external flash using the Extension Cord F5P (③; optional).

Refer to the manual of the flash for details.

When combining two external flashes

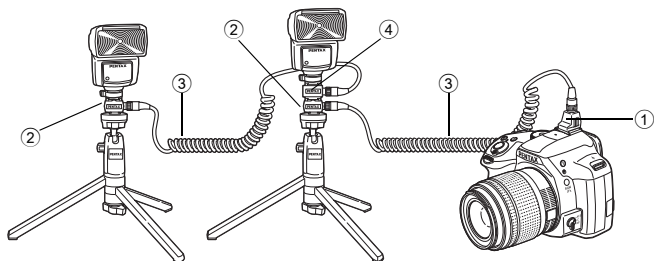

When using multiple external flashes or using an external flash with the built-in flash, P-TTL is used for flash control.

Using the Contrast Control Sync Flash

Combining two or more external flashes (AF540FGZ, AF360FGZ or AF200FG) or using an external flash in combination with the built-in flash allows multiple flash photography (contrast control sync flash photography). This is based on the difference between the amounts of light discharged from multiple units.



The AF200FG must be combined with the AF540FGZ or AF360FGZ.

1 **Connect the external flash to the camera indirectly.**

Refer to p.250 for details.

2 **Set the sync mode for the external flash to contrast-control-sync mode.**

3 **Confirm that both the external flash and built-in flash are fully charged and then take a picture.**



- When using two or more external flashes and the contrast control sync mode is set on the external master flash unit, the flash output ratio is 2 (master unit) : 1 (slave units). When an external flash is used in combination with the built-in flash, the flash output ratio is 2 (external flash) : 1 (built-in flash).
- When using multiple external flashes or using an external flash with the built-in flash, P-TTL is used for flash control.

10 Appendix

Default Settings	254
Functions Available with Various Lens Combinations	261
Cleaning the CMOS Sensor	266
Using the GPS Unit	269
Error Messages	272
Troubleshooting	275
Main Specifications	278
Index	285
WARRANTY POLICY	292

The table below shows the factory default settings.

The functions set in Memory (p.217) are saved even when the camera is turned off.

Reset Setting

Yes: The setting returns to the default setting with the reset function (p.219).

No: The setting is saved even after reset.

Direct Keys

Item	Default Setting	Reset Setting	Page
Sensitivity	ISO AUTO (ISO 100 to 3200)	Yes	p.87
White Balance	AWB	Yes	p.145
Flash Mode	Depends on capture mode	Yes	p.68
Drive Mode	Single Frame Shooting	Yes	p.93 p.119 p.121 p.123

[📷 Rec. Mode] Menu

Item	Default Setting	Reset Setting	Page
Exposure Mode	P	Yes	p.174
Custom Image	Bright	Yes	p.157
Scene Mode	Portrait	Yes	p.84
Digital Filter	No Filter	Yes	p.161
HDR Capture	HDR Capture	Off	p.151
	Auto Align	On	
	Exposure Bracket Value	±2 EV	
Image Capture Settings	File Format	JPEG	p.143
	JPEG Recorded Pixels	16M	p.143
	JPEG Quality	★★★	p.144
	Color Space	sRGB	p.144

Item		Default Setting	Reset Setting	Page
AE Metering		Multi-segment	Yes	p.97
AF Settings	AF.A	Off	Yes	p.103
	Expanded Area AF	Off	Yes	p.105
	AF Active Area	Auto (5 AF Points)	Yes	p.104
	AF Assist Light	On	Yes	p.103
Lens Correction	Distortion Correction	Off	Yes	p.153
	Lat-Chromatic-Ab Adj	On	Yes	
Multi-exposure	Number of Shots	2 times	Yes	p.128
	Auto EV Adjustment	Off	Yes	
Interval Shooting	Interval	00:00'03"	Yes	p.125
	Number of Shots	2 images	Yes	
	Start Interval	Now	Yes	
	Start Time	12:00 AM/00:00	Yes	
D-Range Settings	Highlight Correction	Auto	Yes	p.150
	Shadow Correction	Auto	Yes	
High-ISO NR		Auto	Yes	p.98
Slow Shutter Speed NR		Auto	Yes	p.100
Composition Adjust.	X-Y direction	Center	Yes	p.155
	Rotation	$\pm 0^\circ$		
	Recall Previous Position	Off		
Electronic Level		Off	Yes	p.212
Horizon Correction		Off	Yes	p.118
Shake Reduction		On	Yes	p.116
Input Focal Length		35 mm	Yes	p.264
Live View	Contrast AF	Face Detection	Yes	p.106
	AF Autozoom	Off	Yes	p.109
	Focus Peaking	Off	Yes	p.111
	Grid Display	Off	Yes	p.107
	Info Overlay	On	Yes	
	Histogram Display	Off	Yes	
	Bright/Dark Area	Off	Yes	

Item		Default Setting	Reset Setting	Page	
Instant Review	Display Time	1sec.	Yes	p.214	
	Enlarge Instant Review	On	Yes		
	Save RAW Data	On	Yes		
	Histogram Display	Off	Yes		
	Bright/Dark Area	Off	Yes		
E-Dial Programming	P	Tv, Av,	Yes	p.164	
	Sv	--, ISO,	Yes		
	Tv	Tv, --,	Yes		
	Av	--, Av,	Yes		
	TAv/M	Tv, Av, LINE	Yes		
	B	--, Av,	Yes		
		--, --,	Yes		
Button Customization		One Push File Format	Yes	p.167	
	(still pictures/movies)	Enable AF1	Yes	p.169	
Memory	Digital Filter, HDR Capture, Shooting Info Display	Off	Yes	p.217	
	Other than the above functions	On	Yes		
GPS	ASTRO-TRACER	Action in B Mode	B	Yes	p.269
		Timed Exposure	Off	Yes	
		Exposure Time	5'00"	Yes	
		GPS LED Indicators	On	Yes	
	Calibration		—	—	
	Positioning Interval		1min.	Yes	
	GPS Time Sync		On	Yes	
	Save USER Mode		—	Yes *1	

*1 The saved settings are reset only with [Reset USER Mode] in the [Save USER Mode] screen.

[🎬 Movie] Menu

Item		Default Setting	Reset Setting	Page
Exposure Setting		P	Yes	p.130
Movie Capture Settings	Recorded Pixels		Yes	
	Framerate	30 fps	Yes	
	Quality Level	★★★	Yes	
Recording Sound Level		3	Yes	
Movie SR		On	Yes	
Interval Movie	Interval	3sec.	Yes	p.134
	Recording Time	00:00'12"	Yes	
	Start Interval	Now	Yes	
	Start Time	12:00 AM/00:00	Yes	

Playback Mode Palette

Item	Default Setting	Reset Setting	Page
Image Rotation	—	—	p.185
Digital Filter	Monochrome	Yes	p.191
Resize	Maximum size according to the setting	—	p.189
Cropping	Maximum size according to the setting	—	p.190
Index	—	—	p.196
Protect	—	No	p.222
DPOF	—	No	p.231
Slideshow	—	Yes	p.184
Save as Manual WB	—	—	p.148
Save Cross Processing	—	Yes	p.160
RAW Development	Recorded Pixels:  Quality Level: ★★★	Yes	p.198
Movie Edit	—	—	p.138
Eye-Fi Image Transfer	—	—	p.229

[▶ Playback] Menu

Item		Default Setting	Reset Setting	Page
Slideshow	Display Duration	3sec.	Yes	p.183
	Screen Effect	Off	Yes	
	Repeat Playback	Off	Yes	
Quick Zoom		Off	Yes	p.178
Bright/Dark Area		Off	Yes	
Auto Image Rotation		On	Yes	
Delete All Images		—	—	p.188

[↶ Set-up] Menu

Item		Default Setting	Reset Setting	Page
Language/言語		English	No	p.58
Date Adjustment		01/01/2013	No	p.60
World Time	Time Setting	Hometown	Yes	p.209
	Destination (City)	Same as Hometown	No	
	Destination (DST)	Same as Hometown	No	
	Hometown (City)	According to initial setting	No	
	Hometown (DST)	According to initial setting	No	
Text Size		According to initial setting	No	p.59
Sound Effects	Volume	3	Yes	p.208
	Setting	All on		
LCD Display	Guide Display	On	Yes	p.212
	Display Color	1		
LCD Display Settings		±0	Yes	p.213
Flicker Reduction		50 Hz	No	p.27
Interface Options	Video Out	According to initial setting	No	p.203
	USB Connection	MSC	Yes	p.235
Folder Name		Date	Yes	p.223
Create New Folder		—	—	p.224
File Name		IMGP	No	p.225

Item		Default Setting	Reset Setting	Page
Copyright Information	Embed Copyright Data	Off	No	p.226
	Photographer	—	No	
	Copyright Holder	—	No	
Eye-Fi	Eye-Fi Communication	Off	Yes	p.228
	Communication Info	—	—	
Auto Power Off		1min.	Yes	p.216
AA Battery Type		Auto-detect	Yes	p.216
Reset		—	—	p.219
Pixel Mapping		—	—	p.215
Dust Removal	Dust Removal	—	—	p.266
	Startup Action/ Shutdown Action	Off	Yes	
Sensor Cleaning		—	—	p.267
Format		—	—	p.221
Firmware Info/Options		—	—	p.220

[C Custom Setting] Menu

Item	Default Setting	Reset Setting	Page
1. EV Steps	1/3 EV Steps	Yes	p.92
2. Sensitivity Steps	1 EV Step	Yes	p.88
3. Meter Operating Time	10sec.	Yes	p.97
4. AE-L with AF Locked	Off	Yes	p.96
5. Link AE and AF Point	Off	Yes	p.97
6. Bracketing Order	0 – +	Yes	p.93
7. One-Push Bracketing	Off	Yes	p.95
8. Bulb (B) Mode Options	Mode1	Yes	p.91
9. WB When Using Flash	Auto White Balance	Yes	p.147
10. AWB in Tungsten Light	Subtle Correction	Yes	—
11. Color Temperature Steps	Kelvin	Yes	p.149
12. AF.S Setting	Focus-priority	Yes	p.102
13. AF.C Setting	Focus-priority	Yes	p.103

Item	Default Setting	Reset Setting	Page
14. AF with Remote Control	Off	Yes	p.122
15. Superimpose AF Area	On	Yes	p.104
16. Release While Charging	Off	Yes	p.71
17. Flash in Wireless Mode	On	Yes	p.249
18. Save Rotation Info	On	Yes	p.178
19. Save Menu Location	Reset Menu Location	Yes	p.215
20. Catch-in Focus	Off	Yes	p.113
21. AF Fine Adjustment	Off	Yes	p.112
22. Using Aperture Ring	Disable	Yes	p.265
Reset Custom Functions	—	—	p.219

Functions Available with Various Lens Combinations

All camera capture modes are available when DA, DA L, or FA J lens is used, or when a lens with an **A** position is used with the aperture ring set to the **A** position.

When they are used in a position other than **A**, or other lenses are used, the following restrictions apply.

- ✓: Functions are available when the aperture ring is set to the **A** position.
- #: Some functions are restricted.
- x: Functions are unavailable.

Function	Lens [Mount type]	DA DA L D FA	FA J FA *6	F *6	A	M P
		[KAF] [KAF2] [KAF3]	[KAF] [KAF2]	[KAF]	[KA]	[K]
Autofocus (Lens only) (With AF adapter 1.7x) *1		✓ –	✓ –	✓ –	– #	– #
Manual focus (With the focus indicator)*2 (With matte field)		✓	✓	✓	✓	✓
Quick-shift focus		#*4	x	x	x	x
Focus point selection mode [Auto]		✓	✓	✓	#*8	x
AE Metering [Multi-segment]		✓	✓	✓	✓	x
P/Sv/Tv/Av/TA v mode		✓	✓	✓	✓	#*9
M mode		✓	✓	✓	✓	#
P-TTL auto flash *3		✓	✓	✓	✓	x
Power zoom		–	x	–	–	–
Automatically obtaining the lens focal length information		✓	✓	✓	x	x
Lens Correction		✓*5	x*7	x	x	x

*1 Lenses with a maximum aperture of F2.8 or faster. Only available at the **A** position.

*2 Lenses with a maximum aperture of F5.6 or faster.

*3 Available when using the built-in flash, AF540FGZ, AF360FGZ, AF200FG or AF160FC.

*4 Only available with compatible lenses.

- *5 Distortion Correction is disabled when a DA FISH-EYE 10-17mm lens is used.
- *6 To use an FA SOFT 28mm F2.8 lens, FA SOFT 85mm F2.8 lens, or F SOFT 85mm F2.8 lens, set [22. Using Aperture Ring] to [Enable] in the [C Custom Setting 4] menu. Pictures can be taken with the aperture you set, but only within manual aperture range.
- *7 Only available with an FA 31mm F1.8 Limited, FA 43mm F1.9 Limited, or FA 77mm F1.8 Limited lens.
- *8 Fixed to [Spot].
- *9 Av Automatic Exposure with the aperture open. (The aperture ring has no effect on the actual aperture value.)

Lens names and mount names

DA lenses with a motor and FA zoom lenses with power zoom use the K_{AF2} mount. DA lenses with an ultrasonic motor and no AF coupler use the K_{AF3} mount.

FA single focal length lenses (non-zoom lenses), DA or DA L lenses without a motor, and D FA, FA J and F lenses use the K_{AF} mount.

Refer to respective lens manuals for details. Note that this camera is not equipped with a power zoom function.

Lenses and accessories that cannot be used with this camera

When the aperture ring is set to a position other than **A** or a lens without an **A** position or accessories such as an auto extension tube or auto bellows are used, the camera will not operate unless [22. Using Aperture Ring] is set to [Enable] in the [C Custom Setting 4] menu. Refer to “Using the Aperture Ring” (p.265) for details.

Lens and Built-in Flash

Depending on the lens used with this camera, the use of the built-in flash may not be available or may be limited due to vignetting.

The built-in flash cannot be regulated and fully discharges when A lenses not set to the **A** position, lenses manufactured prior to the A lenses or soft focus lenses are used.

DA, DA L, D FA, FA J, and FA lenses not listed below can be used without problems.

* The following lenses were evaluated without a hood.

Unavailable due to vignetting

Lens Name
DA FISH-EYE 10-17mm F3.5-4.5 ED (IF)
DA 12-24mm F4 ED AL
DA 14mm F2.8 ED (IF)
FA* 300mm F2.8 ED (IF)
DA* 560mm F5.6 ED AW
FA* 600mm F4 ED (IF)
FA* 250-600mm F5.6 ED (IF)

Available with some restrictions

Lens Name	Restrictions
F FISH-EYE 17-28mm F3.5-4.5	Vignetting may occur if the focal length is less than 20 mm.
DA 16-45mm F4 ED AL	When the focal length is less than 28 mm, or when the focal length is 28 mm and the shooting distance is 1 m or less, vignetting may occur.
DA* 16-50mm F2.8 ED AL (IF) SDM	When the focal length is 20 mm or less or when the focal length is 35 mm and the shooting distance is less than 1.5 m, vignetting may occur.
DA 17-70mm F4 AL (IF) SDM	When the focal length is less than 24 mm or when the focal length is 35 mm and the shooting distance is 1 m or less, vignetting may occur.
DA 18-250mm F3.5-6.3 ED AL (IF)	Vignetting may occur if the focal length is less than 35 mm.
DA 18-270mm F3.5-6.3 ED SDM	Vignetting may occur if the focal length is less than 24mm.
FA* 28-70mm F2.8 AL	Vignetting may occur if the focal length is 28 mm and the shooting distance is less than 1 m.
FA SOFT 28mm F2.8/ FA SOFT 85mm F2.8	Built-in flash always discharges fully.

Setting the Focal Length

The Shake Reduction function operates by obtaining the lens information such as focal length. Set the focal length when using a lens for which the focal length information cannot be automatically obtained.

1 Make sure that [Shake Reduction] is activated, and turn the camera off.

Refer to “Reducing Vertical and Horizontal Camera Shake” (p.116) for details.

2 Attach a lens, and turn the camera on.

The [Input Focal Length] screen appears.

3 Turn the rear e-dial (☀️) to set the focal length.

Select from the following focal length values. (The default setting is 35 mm.)

8	10	12	15	18	20	24	28	30	35
40	45	50	55	65	70	75	85	100	120
135	150	180	200	250	300	350	400	450	500
550	600	700	800						

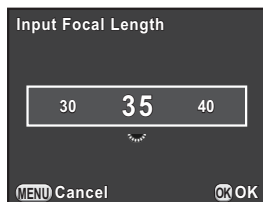

- If the focal length for your lens is not listed above, select the value closest to the actual focal length (example: [18] for 17 mm and [100] for 105 mm).
- When using a zoom lens, select the actual focal length at the zoom setting being used in the same manner.

4 Press the OK button.

The camera is ready to take a picture.



- To change the focal length setting, use [Input Focal Length] in the [📷 Rec. Mode 3] menu.
- When using a lens without an **A** position or a lens with an **A** position with the aperture ring set to a position other than **A**, set [22. Using Aperture Ring] to [Enable] in the [C Custom Setting 4] menu. (p.265)

Using the Aperture Ring

The shutter can be released even if the aperture ring of the D FA, FA, F or A lens is not set to the **A** position or a lens without an **A** position is attached.

Select [Enable] in [22. Using Aperture Ring] of the [C Custom Setting 4] menu.

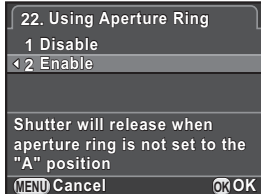

The following restrictions apply depending on the lens being used.

Lens Used	Capture Mode	Restriction
D FA, FA, F, A, M (lens only or with automatic diaphragm accessories such as auto extension tube K)	Av	The aperture remains open regardless of the aperture ring position. The shutter speed changes in relation to the open aperture but an exposure deviation may occur. [F--] appears for the aperture indicator.
D FA, FA, F, A, M, S (with diaphragm accessories such as extension tube K)	Av	Pictures can be taken with a specified aperture value but an exposure deviation may occur. [F--] appears for the aperture indicator.
Manual diaphragm lens such as reflex lens (lens only)	Av	
FA SOFT 28mm, FA SOFT 85mm, F SOFT 85mm (lens only)	Av	Pictures can be taken with a specified aperture value in the manual aperture range. [F--] appears for the aperture indicator. The exposure can be checked with Optical Preview.
All lenses	M	Pictures can be taken with a set aperture value and shutter speed. [F--] appears for the aperture indicator. The exposure can be checked with Optical Preview.



If the aperture ring is set to a position other than **A**, the camera operates in **Av** mode regardless of the mode dial setting except when set to **M** or mode.

If the CMOS sensor becomes dirty or dusty, shadows may appear in the image in certain situations such as when shooting against a white background. This indicates that the CMOS sensor must be cleaned.

Removing Dust by Shaking the CMOS Sensor (Dust Removal)

Shaking the CMOS sensor removes dust from the sensor unit.

- 1 Select [Dust Removal] in the [↖ Set-up 4] menu, and press the four-way controller (▶).**

The [Dust Removal] screen appears.

- 2 Press the OK button.**

The Dust Removal function is activated by shaking the CMOS sensor.

To activate the Dust Removal function every time the camera is turned on and off, set [Startup Action] and [Shutdown Action] to .

When Dust Removal is completed, the camera returns to the [↖ Set-up 4] menu.

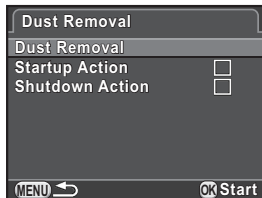

Removing Dust with a Blower

Raise the mirror up and open the shutter when cleaning the CMOS sensor with a blower.

Please contact a PENTAX Service Center for professional cleaning as the CMOS sensor is a precision part. Cleaning services involve a fee.



- The self-timer lamp blinks while cleaning the sensor.
- This camera may generate a vibration sound while cleaning the CMOS sensor. It is not a malfunction.
- You can use the optional imagesensor cleaning kit to clean the CMOS sensor.



- Never use a spray blower or a blower with a brush. They may scratch the CMOS sensor. Also, do not wipe the CMOS sensor with a cloth.
- Do not clean the sensor when the mode dial is set to **B**.
- To prevent dirt and dust from accumulating on the CMOS sensor, keep the body mount cover on the camera when a lens is not attached.
- When the battery level is low, [Not enough battery power remaining to clean sensor] is displayed on the monitor.
- When cleaning the sensor, use the optional AC adapter kit or install a fully charged battery. If the battery capacity becomes low during cleaning, the self-timer lamp blinks rapidly. In this case, stop cleaning immediately.
- Do not put the tip of the blower inside the lens mount area. If the power is turned off, this may cause damage to the shutter, CMOS sensor and the mirror.

- 1 Turn the camera off, and remove the lens.**
- 2 Turn the camera on.**
- 3 Select [Sensor Cleaning] in the [Set-up 4] menu, and press the four-way controller (▶).**

The [Sensor Cleaning] screen appears.

- 4 Press the four-way controller (▲) to select [Mirror Up], and press the OK button.**

The mirror is locked in the up position.

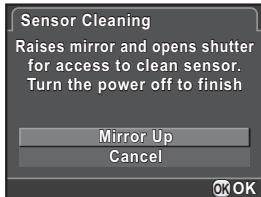

- 5 Clean the CMOS sensor.**

Use a brush-less blower to remove dirt and dust from the CMOS sensor.

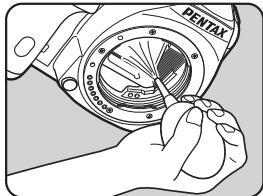

- 6 Turn the camera off.**

The mirror automatically returns to its original position.

- 7 Attach the lens or body mount cover.**

The following functions are available when the optional GPS unit O-GPS1 is attached to this camera.

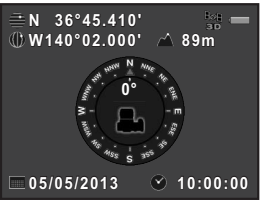
Electronic Compass	Displays the latitude, longitude, altitude of the current location, lens direction and Coordinated Universal Time (UTC) in standby mode.	
ASTROTRACER	Tracks and captures celestial bodies. By matching the movement of the camera's built-in shake reduction unit with the movement of celestial bodies, celestial bodies can be captured as individual points even when shooting with a long exposure setting. (p.270)	
GPS Time Sync	Automatically adjusts the camera's date and time settings using information acquired from GPS satellites.	



- Refer to the manual of the GPS unit for details on how to attach the unit and information on the unit's functions.
- To display the electronic compass, press the **INFO** button twice in standby mode and select [Electronic Compass] from the standby mode display selection screen. (p.29)



"Simple Navigation" cannot be used with this camera.

Shooting Celestial Bodies (ASTROTRACER)

- 1 Select **[GPS]** in the **[Rec. Mode 4]** menu, and press the four-way controller (▶).

The **[GPS]** screen appears.

- 2 Select **[ASTROTRACER]**, and press the four-way controller (▶).

The **[ASTROTRACER]** screen appears.

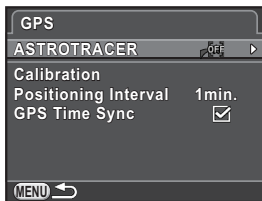

- 3 Select **[Action in B Mode]**, press the four-way controller (▶) to select , and press the OK button.

The **ASTROTRACER** function is enabled when shooting in **B** mode.

To set **[Exposure Time]**, first select the **ON** icon for the **[Timed Exposure]** item in **ASTROTRACER** submenu.

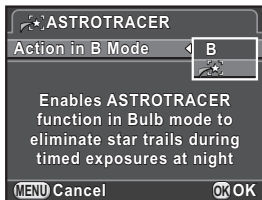

- 4 Press the **MENU** button three times.

The camera is ready to take a picture.

- 5 Set the mode dial to **B**.

- 6 Press the shutter release button fully.

Shooting starts.

7 Press the shutter release button fully again.

Exposure ends.



When [Timed Exposure] is enabled, shooting ends automatically after the set [Exposure Time] has elapsed.



- When you do not want the indicators on the GPS unit to turn on while shooting with the ASTROTRACER function, you can turn them off by selecting the OFF icon for [GPS LED Indicators] in Step 3.
- Refer to the manual of the GPS unit for details on ASTROTRACER.

Error Messages	Description
Memory card full	The SD Memory Card is full and no more images can be saved. Insert a new SD Memory Card or delete unwanted files. (p.52, p.186) You may be able to save more images if you change the image capture settings. (p.142)
No image	There are no images that can be played back on the SD Memory Card.
This image cannot be displayed	You are trying to play back an image in a format not supported by this camera. You may be able to play it back on another brand of camera or a computer.
No card in the camera	There is no SD Memory Card inserted in the camera. (p.52)
No Eye-Fi card inserted	Images cannot be transferred when an Eye-Fi card is not inserted. (p.228)
Cannot use this card	The inserted SD Memory Card is not compatible with this camera.
Memory card error	There is a problem with the SD Memory Card and capturing, playing back and transferring images are not possible. Images on the card may be viewable on a computer but not with this camera.
Card is not formatted	The SD Memory Card you have inserted is unformatted or has been formatted on another device and is not compatible with this camera. Use the card after formatting it with this camera. (p.221)
Card is locked	The write-protect switch on an SD Memory Card you have inserted is locked. Unlock the SD Memory Card. (p.6)
Card is electronically locked	Data is protected by an SD Memory Card security feature.
This image cannot be magnified	You are trying to magnify an image that cannot be magnified.
This image is protected	You are trying to delete an image that is protected. Remove the protection from the image. (p.222)













Error Messages	Description
Not enough battery power remaining to activate Pixel Mapping	Appears during Pixel Mapping if the battery level is insufficient. Install a fully charged battery or use the optional AC adapter kit.
Not enough battery power remaining to clean sensor	Appears during sensor cleaning if the battery level is insufficient. Install a fully charged battery or use the optional AC adapter kit.
Not enough battery power remaining to update the firmware	Appears when trying to update the firmware if the battery level is insufficient. Install a fully charged battery or use the optional AC adapter kit.
Unable to update firmware. There is a problem with the firmware update file	Unable to update the firmware. The update file is damaged. Try downloading the update file again.
Image folder cannot be created	The maximum folder number (999) and file number (9999) are being used, and no more images can be saved. Insert a new SD Memory Card or format the card. (p.221)
Unable to store image	The image could not be saved because of an SD Memory Card error.
Settings not stored	The DPOF settings could not be saved because the SD Memory Card is full. Delete unwanted images and perform the DPOF setting again. (p.186)
The operation could not be completed correctly	The camera was unable to measure the manual white balance (p.147) or use HDR Capture (p.151). Try the operation again.
No more images can be selected	You cannot select more than the maximum number of images for Select & Delete (p.186), Index (p.196), and Eye-Fi Image Transfer (p.229).
Image not found	There are no images that can be transferred in the selected folder. (p.229)
No image can be processed	There are no images that can be processed using the Digital Filter (p.191) or RAW Development (p.198) function.
This image cannot be processed	Appears when you try to perform Resize (p.189), Cropping (p.190), Digital Filter (p.191), or RAW Development (p.198) for images captured with other cameras, or when you try to perform Resize or Cropping for minimum file size images.
The camera failed to create an image	The creation of an index image failed. (p.196)

Error Messages	Description
This function is not available in the current mode	You are trying to set a function that is not available in AUTO , SCN or  mode.
Camera overheated. Disabling Live View temporarily to protect circuitry	Live View cannot be used because the camera's internal temperature is too high. Try using Live View again when the camera has cooled down.
The camera will turn off to prevent damage from overheating	The camera will turn off because its internal temperature gets too hot. Leave the camera turned off and give it enough time to cool down. Turn it on again after a while.
Set the Eye-Fi communication to "SELECT"	Images cannot be transferred when [Eye-Fi Communication] is not set to [SELECT] in [Eye-Fi] of the [ Set-up 2] menu. (p.228)

In rare cases, the camera may not operate correctly due to static electricity. This can be remedied by taking the battery out and putting it back in again. After these procedures are done, if the camera operates correctly, it does not require any repairs.

We recommend checking the following items before contacting a service center.

Problem	Cause	Remedy
The camera does not turn on	Battery is not installed	Check if a battery is installed.
	Battery is not installed properly	Check the orientation of battery. Re-insert battery according to the +/- symbols. (p.47, p.48)
	The battery power is low	Replace with a charged battery or use the optional AC adapter kit.
The shutter cannot be released	The built-in flash is charging	⚡ blinks while the built-in flash is charging. Wait until charging is finished.
	There is no available space on the SD Memory Card	Insert an SD Memory Card with available space or delete unwanted images. (p.73, p.186)
	Recording	Wait until recording is finished.
	The lens aperture ring is set to a position other than A	Set the lens aperture ring to the A position or select [Enable] in [22. Using Aperture Ring] of the [C Custom Setting 4] menu. (p.265)
Autofocus does not work	The subject is difficult to focus on	Autofocus cannot work well for subjects that have low contrast (sky, white walls, etc.), dark colors, intricate designs, rapidly-moving objects or scenery shot through a window or a net-like pattern. Lock focus on another object located at the same distance as your subject, then aim at the target and press the shutter release button fully. Alternatively, use manual focus. (p.110)

Problem	Cause	Remedy
Autofocus does not work	The subject is not in the AF area	Position the subject in the AF area. If the subject is outside the AF area, aim the camera at the subject and lock the focus, then compose a picture and press the shutter release button fully.
	The subject is too close	Move away from the subject and take a picture.
	The focus mode is set to MF	Set the focus mode switch to AFS or C . (p.101)
The AE Lock function does not operate	B mode is set	AE Lock is not available in B mode.
The built-in flash does not discharge	When the flash mode is set to  or  , the flash will not discharge if the subject is bright	Set the flash mode to  (Flash On) or  (Flash On+Red-eye Reduction). (p.68)
	 ,  ,  ,  ,  ,  ,  , or  of SCN mode is set	Select a capture mode other than those shown to the left. (p.82)
The power zoom system does not work	The camera does not have a power zoom function	Use manual zoom.
The USB connection with a computer does not work properly	The USB connection mode is set to [PTP]	Set [USB Connection] to [MSC] in [Interface Options] of the [ Set-up 2] menu. (p.235)

Problem	Cause	Remedy
Shake Reduction does not work	The Shake Reduction function is off	Turn the Shake Reduction function on. (p.116)
	The focal length is not set	If a lens for which the focal length information cannot be obtained is used, set the focal length in the [Input Focal Length] screen. (p.264)
	Shutter speed is too low for the Shake Reduction function to be effective when panning or shooting night scenes, etc.	Turn off the Shake Reduction function and use a tripod.
	The subject is too close	Move away from the subject, or turn off the Shake Reduction function and use a tripod.

Model Description

Type	TTL autofocus, auto-exposure SLR digital camera with a built-in retractable P-TTL flash
Lens Mount	PENTAX KAF ₂ bayonet mount (AF coupler, lens information contacts, K-mount with power contacts)
Compatible Lens	KAF ₃ , KAF ₂ (power zoom not compatible), KAF, KA mount lenses

Image Capture Unit

Image Sensor	Primary color filter, CMOS, Size: 23.7 × 15.7 (mm)
Effective Pixels	Approx. 16.28 megapixels
Total Pixels	Approx. 16.49 megapixels
Dust Removal	SP coating and CMOS sensor operations
Sensitivity (Standard Output)	ISO AUTO: 100 to 51200 (EV steps can be set to 1 EV, 1/2 EV, or 1/3 EV)
Image Stabilizer	Sensor-shift Shake Reduction

File Formats

Recording Formats	RAW (DNG), JPEG (Exif 2.3), DCF2.0 compliant
Recorded Pixels	JPEG: 16M (4928×3264) 12M (4224×2816) 8M (3456×2304) 5M (2688×1792) RAW: 16M (4928×3264)
Quality Level	RAW (12bit): DNG JPEG: ★★★ (Best), ★★ (Better), ★ (Good) RAW and JPEG simultaneously recordable
Color Space	sRGB, AdobeRGB
Storage Media	SD Memory Cards, SDHC Memory Cards, SDXC Memory Cards and Eye-Fi Cards
Storage Folder	Date (100_1018, 100_1019...)/ PENTX (100PENTX, 101PENTX...); "PENTX" can be changed by user

Viewfinder

Type	Pentaprism Finder
Coverage (FOV)	Approx. 100%
Magnification	Approx. 0.92× (50 mm F1.4 at infinity)
Eye-Relief Length	Approx. 21.7 mm (from the view window), Approx. 24.5 mm (from the center of lens)

Diopter Adjustment	Approx. -2.5 to +1.5 m ⁻¹
Focusing Screen	Interchangeable Natural-Bright-Matte III focusing screen

Live View

Type	TTL method using CMOS image sensor
Focusing Mechanism	Contrast detection: Face Detection, Tracking, Select, Spot
Display	Field of view: approx. 100%, Magnified view (2×, 4×, 6×), Grid Display (4 × 4 Grid, Golden Section, Scale), Bright/Dark Area warning, Histogram, Focus Peaking

LCD Monitor

Type	TFT color LCD monitor, wide angle viewing
Size	3.0 inches
Dots	Approx. 921,000 dots
Adjustment	Brightness and colors adjustable

White Balance

Auto	Method using a combination of the CMOS sensor and the light-source detection sensor
Preset Modes	Daylight, Shade, Cloudy, Fluorescent Light (D : Daylight Color, N : Daylight White, W : Cool White, L : Warm White), Tungsten, Flash, CTE , Manual, Color Temperature
Manual	Configuration on monitor (up to 3 settings can be saved), Color Temperature settings, Copying the white balance settings of a captured image
Fine Adjustment	Adjustable ±7 steps on A-B axis and G-M axis

Focusing System

Type	TTL: phase-matching autofocus
Focus Sensor	SAFOX IXi+, 11 points (9 cross type focus points in the center)
Brightness Range	EV -1 to 18 (ISO 100)
AF Modes	AF Single (A.F.S): Focus priority or shutter priority mode AF Continuous (A.F.C): Focus priority or FPS priority mode AF Auto (A.F.A): Automatically switches between A.F.S and A.F.C .
Focus Point Selection Modes	Auto (5 AF Points), Auto (11 AF Points), Select (Expanded Area AF is available), Spot
AF Assist Light	Dedicated LED AF assist light

Exposure Control

Type	TTL open-aperture 77 segment metering Metering Modes: Multi-segment metering, Center-weighted metering, Spot metering
Metering Range	EV 0 to 22 (ISO100 at 50mm F1.4)
Exposure Modes	Auto Picture (AUTO), Scene (SCN), Program (P), Sensitivity Priority (Sv), Shutter Priority (Tv), Aperture Priority (Av), Shutter & Aperture Priority (TAv), Manual (M), Bulb (B) Auto Picture modes: automatically selects from Standard, Portrait, Landscape, Macro, Moving Object, Night Scene Portrait, Night Scene, Blue Sky, Forest Scene modes: Portrait, Landscape, Macro, Moving Object, Night Scene Portrait, Sunset, Blue Sky, Forest, Night Scene, Night Scene HDR, Night Snap, Food, Pet, Kids, Surf & Snow, Backlight Silhouette, Candlelight, Stage Lighting, Museum * Fixed to JPEG in Night Scene HDR mode.
EV Compensation	±5 EV (1/3 EV steps or 1/2 EV steps can be selected)
AE Lock	Can be assigned to the AF/AE-L button from the menu.

Shutter

Type	Electronically controlled vertical-run focal plane shutter
Shutter Speed	Auto: 1/6000 to 30 seconds, Manual: 1/6000 to 30 seconds (1/3 EV steps or 1/2 EV steps), Bulb

Drive Mode

Mode Selection	Single frame, Continuous (Hi, Lo), Self-timer (12 sec., 2 sec.), Remote Control (0 sec., 3 sec.), Exposure Bracketing (3 frames)
Continuous FPS	Approx. 6 fps (JPEG, Continuous Hi), Approx. 3 fps (JPEG, Continuous Lo)

Built-in Flash

Type	Built-in retractable P-TTL pop-up flash Guide number: approx. 12 (ISO100/m) Angle of view coverage: equivalent to 28 mm in 35 mm format
Flash Modes	P-TTL, Red-eye Reduction, Slow-speed Sync, Trailing Curtain Sync; High-speed Sync and Wireless Sync are also available with a PENTAX dedicated external flash.
Sync Speed	1/180 sec.
Flash Exposure Compensation	-2.0 to +1.0 EV

Capture Functions

Custom Image	Bright, Natural, Portrait, Landscape, Vibrant, Radiant, Muted, Bleach Bypass, Reversal Film, Monochrome, Cross Processing
Noise Reduction	High-ISO NR, Slow Shutter Speed NR
Dynamic Range Settings	Highlight Correction, Shadow Correction
Lens Correction	Distortion Correction, Lateral Chromatic Aberration Correction
Digital Filter	Extract Color, Toy Camera, Retro, High Contrast, Shading, Invert Color, Color
HDR Capture	Auto, HDR 1, HDR 2, HDR 3 Auto Align (automatic composition correction) Exposure Bracket Value: ± 1 EV, ± 2 EV, ± 3 EV
Multi-exposure	Number of shots: 2-9, Exposure adjusted automatically.
Interval Shooting	Shooting interval: 3 sec. to 24 hr.; Start Interval setting: immediately, from the set time; Number of shots: up to 999 images
Horizon Correction	SR On: adjusts up to ± 1 degree, SR Off: adjusts up to ± 1.5 degrees
Composition Adjustment	Adjustment range of ± 1.0 mm (when rotated: ± 0.5 mm) up, down, left or right; rotating range of ± 1 degree
Electronic Level	Displayed in viewfinder (horizontal direction only); displayed on LCD monitor (horizontal direction and vertical direction)

Movie

File Format	MPEG-4 AVC/H.264
Recorded Pixels	FullHD (1920×1080, 16:9 , 30 fps/25 fps/24 fps), HD (1280×720, 16:9 , 60 fps/50 fps/30 fps/25 fps/24 fps), VGA (640×480, 4:3 , 30 fps/25 fps/24 fps)
Quality Level	★★★ (Best), ★★ (Better), ★ (Good)
Sound	Built-in monaural microphone; recording sound level can be adjusted.
Recording Time	Up to 25 minutes; automatically stops recording if the internal temperature of the camera becomes high.
Custom Image	Bright, Natural, Portrait, Landscape, Vibrant, Radiant, Muted, Bleach Bypass, Reversal Film, Monochrome, Cross Processing
Digital Filter	Extract Color, Toy Camera, Retro, High Contrast, Invert Color, Color
Interval Movie	Recording interval: 3 sec., 5 sec., 10 sec., 30 sec., 1 min., 5 min., 10 min., 30 min., 1 hr.; Recording time: 4 sec. to 99 hr.; Start Interval setting: immediately, from the set time * The file format is Motion JPEG (AVI).

Playback Functions

Playback View	Single frame, multi-image display (4, 9, 16, 36, and 81 thumbnails), display magnification (up to 16×, scrollable, quick zoom), image rotation, histogram display (Y histogram, RGB histogram), bright/dark area warning, auto image rotation, detailed information display, copyright information display (photographer, copyright holder), GPS data (latitude, longitude, altitude, direction, Coordinated Universal Time (UTC)), folder display, calendar filmstrip display, slideshow, wireless image transfer with Eye-Fi
Delete	Single image, all images, select & delete, folder, instant review image
Digital Filter	Monochrome, Extract Color, Toy Camera, Retro, High Contrast, Shading, Invert Color, Color, Tone Expansion, Sketch, Water Color, Pastel, Posterization, Miniature, Soft, Starburst, Fish-eye, Slim, Base Parameter Adj
RAW Development	File Format (JPEG), Image Capture Settings (Aspect Ratio, Recorded Pixels, Quality Level, Color Space), Lens Correction (Distortion Correction, Lateral Chromatic Aberration Correction), Custom Image, White Balance, Sensitivity, High-ISO NR, Shadow Correction
Edit	Resize, Cropping (aspect ratio can be changed and tilt correction is available), Index, Movie Edit (divide or delete selected frames), Capturing a JPEG still picture from a movie, Save RAW data (if JPEG data is available in buffer memory)

Customization

USER Mode	Up to 2 user-defined settings can be saved.
Custom Functions	22 items
Mode Memory	12 items
E-Dial Programming	Electronic dials (front/rear): customizable to each exposure mode.
Button Customization	RAW/Fx button: One Push File Format, Exposure Bracketing, Optical Preview, Digital Preview, Composition Adjustment, AF Active Area AF/AE-L button: Enable AF1, Enable AF2, Cancel AF, AE Lock
Text Size	Standard, Large
World Time	World Time settings for 75 cities (28 time zones)
AF Fine Adjustment	±10 steps, adjustment for all lenses or individual lenses (up to 20 can be saved)
Copyright Information	Names of "Photographer" and "Copyright Holder" are embedded to the image file.

Power Supply

Battery Type	Rechargeable Lithium-ion Battery D-LI109 With AA battery holder D-BH109 (optional), four AA batteries (lithium, Ni-MH rechargeable, alkaline) can be used.
AC Adapter	AC Adapter kit K-AC128 (optional)
Battery Life	(With D-LI109) Number of recordable images (with 50% flash usage): approx. 410 images, (without flash usage): approx. 480 images Playback time: approx. 270 minutes * Tested in compliance with CIPA standard using a new rechargeable lithium-ion battery under the temperature at 23°C. Actual results may vary depending on the shooting conditions/circumstances.

Interfaces

Connection Port	USB 2.0 (high-speed compatible), AV output terminal, Cable release terminal
USB Connection	MSC/PTP
Video Output Format	NTSC/PAL

Dimensions and Weight

Dimensions	Approx. 129.0 mm (W) × 96.5 mm (H) × 70.0 mm (D) (excluding the hot shoe, operation parts and other protrusions)
Weight	Approx. 650 g (loaded and ready with the dedicated battery and SD Memory Card), Approx. 590 g (body only)

Accessories

Package Contents	USB Cable I-USB7, Strap O-ST132, Rechargeable Lithium-ion Battery D-LI109, Battery Charger D-BC109, AC plug cord, Software (CD-ROM) S-SW138 <Mounted on the camera> Eyecup F _R , Hot shoe cover F _K , Body mount cover
Software	SILKYPIX Developer Studio 3.0 LE

● Approximate Image Storage Capacity and Playback Time

When using the fully charged battery or new AA batteries

Battery	Temperature	Normal Shooting	Flash Photography		Playback Time
			50% Use	100% Use	
D-LI109	23°C	480	410	360	270 minutes
	0°C	360	300	250	210 minutes
AA lithium batteries *1	23°C	1250	710	500	560 minutes
AA Ni-MH rechargeable batteries (1900mAh)	23°C	580	380	290	300 minutes
AA alkaline batteries	23°C	170	100	70	240 minutes

The image storage capacity (normal recording and flash use 50%) is based on measuring conditions in accordance with CIPA standards, while other data is based on our measuring conditions. Some deviation from the above figures may occur in actual use depending on the selected capture mode and shooting conditions.

*1 Tested using the Energizer Ultimate Lithium Batteries.

● Approximate Image Storage Capacity by Size

When using a 2 GB SD Memory Card

Recorded Pixels	JPEG Quality			RAW
	★★★	★★	★	
16M (4928×3264)	214	379	749	76
12M (4224×2816)	289	512	1007	—
8M (3456×2304)	429	758	1463	—
5M (2688×1792)	706	1229	2363	—

The number of storable images may vary depending on the subject, shooting conditions, selected capture mode and SD Memory Card, etc.

Symbols

[Rec. Mode] menu 77, 254
[Movie] menu 79, 130, 257
[Playback] menu 177, 258
[Set-up] menu 206, 258
[Custom Setting] menu 80, 259
(Playback) button 21, 23, 72
(Green) button 20
(Flash pop-up) button	... 21, 71
(EV Compensation) button 20, 23, 92
Standard 83
Portrait 83, 84
Landscape 83, 84
Macro 83, 84
Moving Object 83, 84
Night Scene Portrait	... 83, 84
Sunset 83, 84
Blue Sky 83, 84
Forest 83, 84
Night Scene 84
Night Scene HDR 84
Night Snap 84
Food 84
Pet 84
Kids 84
Surf & Snow 84
Backlight Silhouette 84
Candlelight 85
Stage Lighting 85
Museum 85
Movie 132
A	
AA batteries 48
AC adapter 50

Accessories 18
Adding the date (DPOF) 232
AdobeRGB 144
AE Lock 96
AE Metering 97
AF area 108
AF Assist Light 19, 65, 103
AF coupler 19
AF Fine Adjustment 112
AF frame 65, 67
AF point 104
A.F.A. 103
A.F.C. 103
A.F.S. 102
AF/AE-L button	... 21, 101, 169
Alkaline batteries 48
Aperture Priority Automatic Exposure mode Av 89
Aspect Ratio 131, 190
ASTROTRACER 270
AWB (White Balance) 145
AUTO (Auto Picture) mode 64, 83
Auto Flash Discharge 68
Auto Image Rotation 178
Auto Picture Mode AUTO 64, 83
Auto Power Off 216
Av (Aperture Priority Automatic Exposure) mode 89
AV device 202
B	
B (Bulb Exposure) mode 91
Backlight Silhouette 84
Base Parameter Adj (Digital Filter) 192
Battery 45

Battery type	216
Bleach Bypass (Custom Image)	157
Blue Sky 	83, 84
Body mount cover	54
Bracketing shooting	93
Bright (Custom Image)	157
Bright areas	34
Bright/Dark Area warning	178, 214
Brightness adjustment	150
Built-in flash	68
Bulb shooting	91
Button Customization	164







C

Cable release terminal	19
Calendar Filmstrip Display ...	181
Camera shake	116, 131
Candlelight 	85
Capture mode	82
Card access lamp	19
Catch-in Focus	113
CD-ROM	237
Center-weighted metering	97
Charging the battery	45
City	211
Cleaning the sensor	266
Cloudy (White Balance)	145
Color (Digital Filter)	161, 191
Color Space	144
Color Temperature (White Balance)	149
Composition Adjustment	155
Compression ratio	144
Computer	233
Connection cable cover ...	19, 50
Continuous mode A.F.C	103
Continuous playback	183
Continuous Shooting	123

Contrast (Custom Image)	159
Contrast AF	106
Contrast Control Sync	252
Contrast detection AF	101
Control panel	28, 39
Copyright Holder	226
Correcting distortion	153
Creating new folders	224
Cropping images	190
Cross Processing (Custom Image)	157
CTE (White Balance)	145
Custom Image	157
[C Custom Setting] menu	80, 259

D

Dark areas	34
Date Adjustment	60
Daylight (White Balance)	145
Default settings	254
LV /  (Delete) button	23, 73
Deleting	73, 186
Deleting a single image	73
Deleting all images	188
Destination	209
Detailed Information Display	31
Developing RAW images	198, 237
Digital Filter	161, 191
Digital Preview	115
Diopter adjustment	56
Diopter adjustment lever	19, 56
Direct keys	38, 76, 254
Display Color	212
Display language	58
Distortion	153
DNG	143
DPOF	231

- D-Range Settings 151
- Drive Mode 76
- DST 59, 209
- Dust Removal 266
- Dynamic Range 150
- E**
- E-dial 164
- E-Dial Programming 164
- Electronic Compass 29, 269
- Electronic Level 29, 37, 212
- Enlarge Instant Review 214
- Error messages 272
- EV Compensation 92
-  (EV Compensation) button
..... 20, 23, 92
- Exif 226
- Expanded Area AF 105
- Exposure 87
- Exposure Bracket Value 152
- Exposure Bracketing 93
- Exposure modes 86, 89
- Exposure setting for movies
..... 130
- External flash 245
- Extract Color (Digital Filter)
..... 161, 191
- Eyecup 56
- Eye-Fi card 228
- Eye-Fi Image Transfer 229
- F**
- Face Detection (Contrast AF)
..... 106
- File Format 143
- File Name 225
- File naming system 144
- File number 218, 226
- Filter 161
- Filter Effect (Custom Image)
..... 159
- Fine Sharpness (Custom Image)
..... 159
- Firmware 220
- Firmware Info/Options 220
- Fish-eye (Digital Filter) 192
- Flash 68, 241
- Flash (White Balance) 145
- Flash Exposure Compensation
..... 70
- Flash On 68
-  (Flash pop-up) button ...21, 71
- Flicker Reduction 27
- Fluorescent Light (White
Balance) 145
- Focus indicator 65
- Focus lock 65
- Focus mode 101
- Focus mode switch 21, 65
- Focus Peaking 111
- Focusing 101
- Focusing point 104
- Focusing ring 110
- Focus-priority 102, 103
- Folder Display 180
- Folder Name 223
- Food  84
- Forest  83, 84
- Format 221
- Four-way controller ()
..... 22, 23, 38, 76
- FPS-priority 103
- Framerate 131
- Front e-dial () 21, 23
- G**
- GPS 269
- GPS Time Sync 269
- Green Button 20, 164
- Guide Display 83, 164, 212
- Guide indicators 34
- Guide number 244

H

HDR Capture	151
High Contrast (Digital Filter)	161, 191
High Dynamic Range Image Capture	151
High/Low Key Adjustment (Custom Image)	159
High-ISO NR	98
Highlight Correction	150
High-speed Sync	247
Histogram Display	30, 33, 214
Hometown	209
Horizon Correction	118
Hot shoe	19
Hue (Custom Image)	159

I

Image Capture Settings	142
Image finishing tone	157
Image plane indicator	19
Image Rotation	185
Image storage capacity	284
Index image	196

INFO button

.....	21, 23, 24, 30, 181
Info Overlay	107
Initial settings	58
Initializing a memory card	221
Input Focal Length	264
Installing software	237
Instant Review	66, 214
Interface Options	203, 235
Interval Movie	134
Interval Shooting	125
Invert Color (Digital Filter)	161, 191
ISO sensitivity	87

J

JPEG	143
JPEG Quality	144
JPEG Recorded Pixels	143

K







Kelvin	149
Kids ☺	84

L

Landscape ▲	83, 84
Landscape (Custom Image)	157
Language setting	58
Language/言語	58
Lateral chromatic aberration	153
LCD color tuning	213
LCD Display	212
LCD Display Settings	213
LCD Monitor	24
Lens	54, 261
Lens Correction	153
Lens information contacts	19
Lens mount cover	54
Lens mount index	19, 55
Lens unlock button	21, 55
Lens with aperture ring	265
Lithium batteries	48
Live View	26, 67
Locking the exposure	96
Long exposure	91
LV /☒ (Live View/Delete) button	21, 23, 26, 67, 73

M

M (Manual Exposure) mode ...	89
Macintosh	234
Macro ☼	83, 84
Magnifying images	109, 179
Main switch	20, 23, 57
Manual Exposure mode M	89





Manual focus MF	110
Manual White Balance	147
Matte field	110
Memory	217
Memory card	52
MENU button	22, 23, 40
Menu display	215
Menu operation	40
Meter operating time	97
MF (Manual focus)	110
Microphones	19
Miniature (Digital Filter)	192
Mired	149
Mirror	19
Mode dial	21, 82
Monitor	213
Monitor display	24
Monochrome (Custom Image)	157
Monochrome (Digital Filter)	191
Movie	130
Movie Capture Settings	130
Movie Edit	138
[ Movie] menu	79, 130, 257
Movie SR	131
Moving Object 	83, 84
MSC	235
Multi-exposure	128
Multiple flash shooting	251
Multi-segment metering	97
Museum 	85
Muted (Custom Image)	157
N	
Natural (Custom Image)	157
Night Scene 	84
Night Scene HDR 	84
Night Scene Portrait 	83, 84
Night Snap 	84

Ni-MH rechargeable batteries	48
Noise Reduction	98
NTSC	203

O

OK button	21, 23, 105
One-Push Bracketing	95
One Push File Format	168
Optical Preview	114
Output format	203

P

P (Program Automatic Exposure) mode	89
PAL	203
Pastel (Digital Filter)	192
Pet 	84
Photographer information	226
Pixel Mapping	215
Pixels	131, 143
Playback	72
 (Playback) button	21, 23, 72
Playback Info Display	30
[ Playback] menu	177, 258
Playback mode palette	176, 257
Playback time	284
Playing back movies	136
Portrait 	83, 84
Portrait (Custom Image)	157
Posterization (Digital Filter)	192
Power	57
Preview	114
Printing	231
Program Automatic Exposure mode P	89
Protect	222
Provided software	237
PTP	235

P-TTL 246

Q

Quality Level 131, 144

Quick Zoom 178

R

Radiant (Custom Image) 157

RAW 143

RAW Development 198, 237

RAW/Fx button 21, 167

Rear e-dial () 21, 23

[ Rec. Mode] menu 77, 254

Recorded Pixels 131, 143

Recording Sound Level 131

Red-eye reduction 68

Release 66

Release-priority 102

Remote Control 121

Remote control receiver
..... 19, 122

Reset 219

Resize 189

Retro (Digital Filter) 161, 191

Reversal Film (Custom Image)
..... 157

RGB Histogram Display ... 30, 33

Rotation 185

S

Saturation (Custom Image)
..... 159

Save as Manual WB 148

Save Cross Processing 160

Save RAW Data 72, 214

Save Settings 170

Scene mode **SCN** 84

SD Memory Card 52, 221

Select (Contrast AF)
..... 106

Select & Delete 186

Self-timer 119

Self-timer lamp 19, 120

Sensitivity 87, 199

Sensitivity Priority (Automatic
Exposure) mode **Sv**

..... 89

Sensor Cleaning 267

[ Set-up] menu 206, 258

Shade (White Balance) 145

Shading (Digital Filter)
..... 161, 191

Shadow Correction 150

Shake Reduction 116

Sharpness (Custom Image)
..... 159

Shooting celestial bodies 270

Shooting Info Display 29

Shooting information 24

Shutter & Aperture Priority
Automatic Exposure **TAv** 89

Shutter Priority Automatic
Exposure mode **Tv** 89

Shutter release button
..... 20, 23, 65

SILKYPIX Developer Studio
..... 237

Single image display 30, 72

Single mode **AfS** 102

Sketch (Digital Filter) 191

Slideshow 183

Slim (Digital Filter) 192

Slow Shutter Speed NR 100

Slow-speed Sync 68, 242

Soft (Digital Filter) 192

Software 220, 237

Sound Effects 208

Speaker 19



Specifications 278

Spot (Contrast AF) 106

Spot metering 97

sRGB 144

Stage Lighting () 85

Standard 	83
Standard Information Display	
.....	30
Standby mode	24
Starburst (Digital Filter)	192
Status screen	25
Strap	44
Sunset 	83, 84
Superimpose AF Area	35
Surf & Snow 	84
Sv (Sensitivity Priority Automatic Exposure) mode	
.....	89
T	
TAv (Shutter & Aperture Priority Automatic Exposure)	89
Temperature warning	27
Terminal cover	19
Text Size	59
Thumbnail display	181
Tone Expansion (Digital Filter)	
.....	191
Toning (Custom Image)	159
Toy Camera (Digital Filter)	
.....	161, 191
Tracking (Contrast AF)	
.....	106
Trailing Curtain Sync	68
Tripod socket	19
TTL phase-matching autofocus	
.....	101
Tungsten (White Balance)	145
Tv (Shutter Priority Automatic Exposure) mode	89
U	
Updating software	220
USB Connection	235
USER mode	170
User registration	239

V

Vibrant (Custom Image)	157
Video terminal	202
VIDEO/PC output terminal	
.....	202, 236
Viewfinder	35, 56
Volume	131, 208

W

Water Color (Digital Filter)	
.....	191
White Balance	145
Windows	234
Wireless Mode	68, 248
World Time	209
Write-protect	6

Z

Zoom lens	65
-----------	----

All PENTAX cameras purchased through authorized bona fide photographic distribution channels are guaranteed against defects of material or workmanship for a period of twelve months from date of purchase. Service will be rendered, and defective parts will be replaced without cost to you within that period, provided the equipment does not show evidence of impact, sand or liquid damage, mishandling, tampering, battery or chemical corrosion, operation contrary to operating instructions, or modification by an unauthorized repair shop. The manufacturer or its authorized representatives shall not be liable for any repair or alterations except those made with its written consent and shall not be liable for damages from delay or loss of use or from other indirect or consequential damages of any kind, whether caused by defective material or workmanship or otherwise; and it is expressly agreed that the liability of the manufacturer or its representatives under all guarantees or warranties, whether expressed or implied, is strictly limited to the replacement of parts as hereinbefore provided. No refunds will be made on repairs by non-authorized PENTAX service facilities.

Procedure During 12-month Warranty Period

Any PENTAX which proves defective during the 12-month warranty period should be returned to the dealer from whom you purchased the equipment or to the manufacturer. If there are no representatives of the manufacturer in your country, send the equipment to the manufacturer, with postage prepaid. In this case, it will take a considerable length of time before the equipment can be returned to you owing to the complicated customs procedures required. If the equipment is covered by warranty, repairs will be made and parts replaced free of charge, and the equipment will be returned to you upon completion of servicing. If the equipment is not covered by warranty, regular charges of the manufacturer or of its representatives will apply. Shipping charges are to be borne by the owner. If your PENTAX was purchased outside of the country where you wish to have it serviced during the warranty period, regular handling and servicing fees may be charged by the manufacturer's representatives in that country. Notwithstanding this, your PENTAX returned to the manufacturer will be serviced free of charge according to this procedure and warranty policy. In any case, however, shipping charges and customs clearance fees to be borne by the sender. To prove the date of your purchase when

required, please keep the receipt or bills covering the purchase of your equipment for at least a year. Before sending your equipment for servicing, please make sure that you are sending it to the manufacturer's authorized representatives or their approved repair shops, unless you are sending it directly to the manufacturer. Always obtain a quotation for the service charge, and only after you accept the quoted service charge, instruct the service station to proceed with the servicing.

- **This warranty policy does not affect the customer's statutory rights.**
- **The local warranty policies available from PENTAX distributors in some countries can supersede this warranty policy. Therefore, we recommend that you review the warranty card supplied with your product at the time of purchase, or contact the PENTAX distributor in your country for more information and to receive a copy of the warranty policy.**



The CE Mark is a Directive conformity mark of the European Union.

For customers in USA**STATEMENT OF FCC COMPLIANCE**

This device complies with Part 15 of the FCC Rules. Operation is subject to the following two conditions: (1) This device may not cause harmful interference, and (2) this device must accept any interference received, including interference that may cause undesired operation.

Changes or modifications not approved by the party responsible for compliance could void the user's authority to operate the equipment.

This equipment has been tested and found to comply with the limits for a Class B digital device, pursuant to part 15 of the FCC Rules.

These limits are designed to provide reasonable protection against harmful interference in a residential installation. This equipment generates, uses and can radiate radio frequency energy and, if not installed and used in accordance with the instructions, may cause harmful interference to radio communications. However, there is no guarantee that interference will not occur in a particular installation.

If this equipment does cause harmful interference to radio or television reception, which can be determined by turning the equipment off and on, the user is encouraged to try to correct the interference by one or more of the following measures:

- Reorient or relocate the receiving antenna.
- Increase the separation between the equipment and receiver.
- Connect the equipment into an outlet on a circuit different from that to which the receiver is connected.

* Consult the dealer or an experienced radio/TV technician for help.

For customers in Canada

This Class B digital apparatus complies with Canadian ICES-003.

Pour les utilisateurs au Canada

Cet appareil numérique de la classe B est conforme à la norme NMB-003 du Canada.

FOR CALIFORNIA, U.S.A. ONLY

Perchlorate Material-special handling may apply.

The lithium battery used in this camera contains perchlorate material, which may require special handling.

See www.dtsc.ca.gov/hazardouswaste/perchlorate

Declaration of Conformity

According to 47CFR, Parts 2 and 15 for
Class B Personal Computers and Peripherals

We: PENTAX RICOH IMAGING AMERICAS CORPORATION

Located at: 633 17th Street, Suite 2600
Denver, Colorado 80202 U.S.A.
Phone: 800-877-0155 FAX: 303-790-1131

Declare under sole responsibility that the product identified herein complies with 47CFR Parts 2 and 15 of the FCC rules as a Class B digital device. Each product marketed is identical to the representative unit tested and found to be compliant with the standards. Records maintained continue to reflect the equipment being produced can be expected to be within the variation accepted, due to quantity production and testing on the statistical basis as required by 47CFR §2.909. Operation is subject to the following two conditions: (1) This device may not cause harmful interference, and (2) This device must accept any interference received, including interference that may cause undesired operation. The above named party is responsible for ensuring that the equipment complies with the standards of 47CFR §15.101 to §15.109.

Product Name: Digital Camera

Model Number: K-50

Contact person: Customer Service Manager

Date and Place: May, 2013, Colorado

Information for Users on Collection and Disposal of Old Equipment and Used Batteries



1. In the European Union

These symbols on the products, packaging and/or accompanying documents mean that used electrical and electronic equipment and batteries should not be mixed with general household waste.

Used electrical/electronic equipment and batteries must be treated separately and in accordance with legislation that requires proper treatment, recovery and recycling of these products.



By disposing of these products correctly you will help ensure that the waste undergoes the necessary treatment, recovery and recycling and thus prevent potential negative effects on the environment and human health which could otherwise arise due to inappropriate waste handling.

If a chemical symbol is added beneath the symbol shown above, in accordance with the Battery Directive, this indicates that a heavy metal (Hg = Mercury, Cd = Cadmium, Pb = Lead) is present in the battery at a concentration above an applicable threshold specified in the Battery Directive.

For more information about collection and recycling of used products, please contact your local authorities, your waste disposal service or the point of sale where you purchased the products.

2. In other countries outside the EU

These symbols are only valid in the European Union. If you wish to discard used products, please contact your local authorities or dealer and ask for the correct method of disposal.

For Switzerland: Used electrical/electronic equipment can be returned free of charge to the dealer, even when you don't purchase a new product. Further collection facilities are listed on the home page of www.swico.ch or www.sens.ch.

Memo

PENTAX RICOH IMAGING CO., LTD.

2-35-7, Maeno-cho, Itabashi-ku, Tokyo 174-8639, JAPAN
(<http://www.pentax.jp>)

PENTAX RICOH IMAGING FRANCE S.A.S. 112 Quai de Bezons, B.P. 204, 95106 Argenteuil Cedex, FRANCE
(European Headquarters) (HQ - <http://www.pentax.eu>)
(France - <http://www.pentax.fr>)

PENTAX RICOH IMAGING DEUTSCHLAND GmbH Julius-Vosseler-Strasse 104, 22527 Hamburg, GERMANY
(<http://www.pentax.de>)

PENTAX RICOH IMAGING UK LTD. PENTAX House, Heron Drive, Langley, Slough, Berks SL3 8PN, U.K.
(<http://www.pentax.co.uk>)

PENTAX RICOH IMAGING AMERICAS CORPORATION 633 17th Street, Suite 2600, Denver, Colorado 80202, U.S.A.
(<http://www.pentaximaging.com>)

PENTAX RICOH IMAGING CANADA INC. 1770 Argentia Road Mississauga, Ontario L5N 3S7, CANADA
(<http://www.pentax.ca>)

PENTAX RICOH IMAGING CHINA CO., LTD. 23D, Jun Yao International Plaza, 789 Zhaojiabang Road, Xu Hui District, Shanghai, 200032, CHINA
(<http://www.pentax.com.cn>)

<http://www.pentax.jp/english>

- Specifications and external dimensions are subject to change without notice.